

# KOMATSU®

## PC400-8R PC400LC-8R

**PC**  
**400**

#### HORSEPOWER

Gross: 270 kW 362 HP / 1900 min<sup>-1</sup>

Net: 257 kW 345 HP / 1900 min<sup>-1</sup>

#### OPERATING WEIGHT

PC400-8R: 41740 – 42590 kg

PC400LC-8R: 42290 – 43200 kg

#### BUCKET CAPACITY

1.30 – 2.80 m<sup>3</sup>



Photos may include optional equipment.

# WALK-AROUND





### PRODUCTIVITY, ECOLOGY & ECONOMY

- Low Fuel Consumption by Total Control of the Engine, Hydraulic and Electronic System
- High Power and Low Emission Engine
- Low Operation Noise
- Large Digging Force
- Variable Track Gauge (Optional)

### COMFORT & SAFETY

- Large Comfortable Cab
- ROPS Cab (ISO 12117-2)
- Automatic Air Conditioner (A/C) (Optional)
- Rear View Monitor System (Optional)

\* Information and Communication Technology

### ICT\* & KOMTRAX

- Large Multi-lingual Liquid Crystal Display (LCD) Monitor
- Equipment Management Monitoring System
- KOMTRAX

### MAINTENANCE & RELIABILITY

- Easy Maintenance
- Excellent Reliability and Durability

	PC400-8R	PC400LC-8R
<b>HORSEPOWER</b>	Gross: 270 kW 362 HP / 1900 min <sup>-1</sup> Net: 257 kW 345 HP / 1900 min <sup>-1</sup>	270 kW 362 HP / 1900 min <sup>-1</sup> 257 kW 345 HP / 1900 min <sup>-1</sup>
<b>OPERATING WEIGHT</b>	41740 – 42590 kg	42290 – 43200 kg
<b>BUCKET CAPACITY</b>	1.30 – 2.80 m <sup>3</sup>	1.30 – 2.80 m <sup>3</sup>

# PRODUCTIVITY, ECOLOGY & ECONOMY

## Komatsu Technology

Komatsu develops and produces all major components, such as engines, electronics and hydraulic components, in house. With this “Komatsu Technology” and adding customer feedback, Komatsu is achieving great advancements in technology. To achieve both high levels of productivity and economical performance, Komatsu has developed the main components with a total control system. The result is a new generation of high performance and environment-friendly excavators.

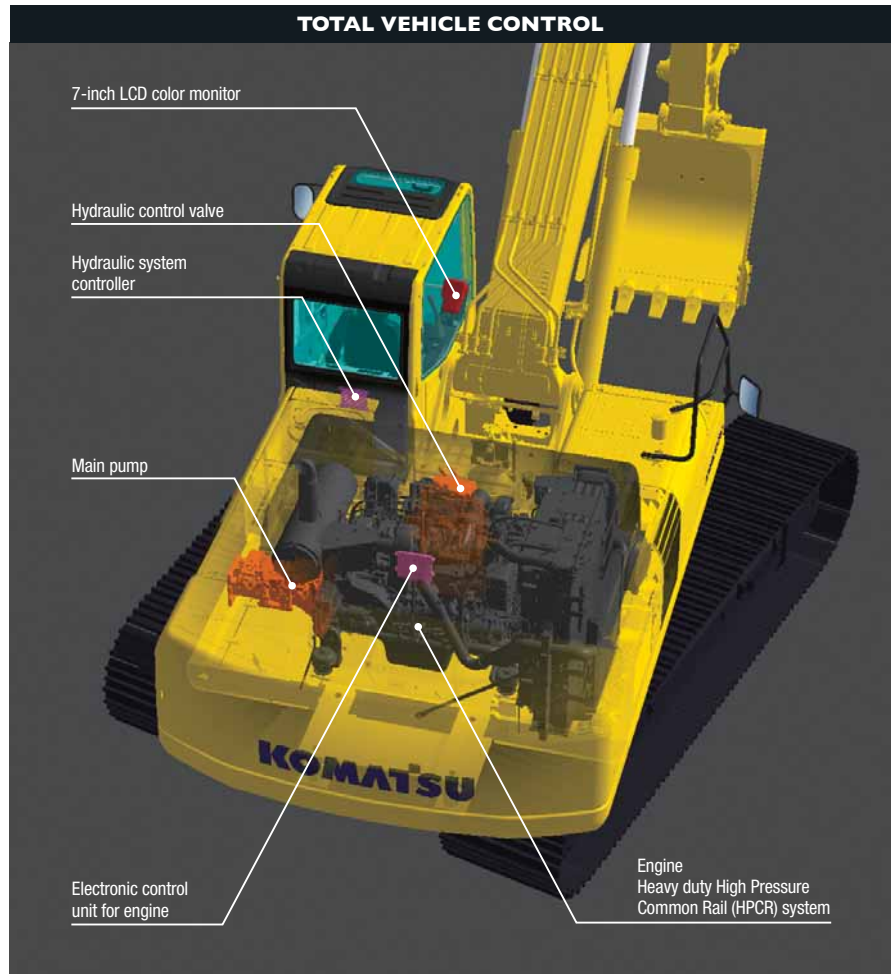
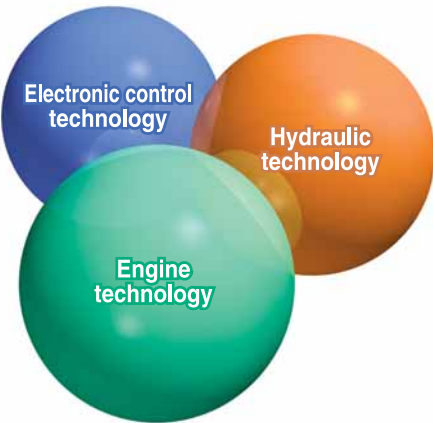

## High Power Komatsu SAA6D125E-5 Engine

The PC400-8R gets its exceptional power and work capacity from a Komatsu SAA6D125E-5 engine. Output is 257 kW 345 HP, providing increased hydraulic power and improved fuel efficiency. The SAA6D125E-5 engine is U.S. EPA Tier 2 and EU Stage 2 emissions equivalent. The SAA6D125E-5 engine adopts the electronically controlled Heavy Duty High Pressure Common Rail (HPCR) fuel injection system.



## Low Operation Noise

Enables a low noise operation using the low-noise engine and methods to cut noise at source. Ambient noise meets the EU Stage 2 noise regulation.

## Excellent Machine Stability

Large counterweight offers superior machine stability and balance.

## Idling Caution

To prevent unnecessary fuel consumption, an idling caution is displayed on the monitor, if the engine idles for 5 minutes or more.



### ECO Gauge that Assists Energy-saving Operations

Equipped with the ECO gauge that can be recognized at a glance on the right of the multi-function color monitor for environment-friendly energy-saving operations. Allows focus on operation in the green range with reduced CO<sub>2</sub> emissions and efficient fuel consumption.



ECO gauge

### Working Modes Selectable

The PC400-8R excavator is equipped with five working modes (P, E, L, B and ATT mode). Each mode is designed to match engine speed and pump output to the application. This provides the flexibility to match equipment performance to the job at hand.



Working Mode	Application	Advantage
<b>P</b>	Power mode	<ul style="list-style-type: none"> <li>• Maximum production/power</li> <li>• Fast cycle times</li> </ul>
<b>E</b>	Economy mode	<ul style="list-style-type: none"> <li>• Good cycle times</li> <li>• Better fuel economy</li> </ul>
<b>L</b>	Lifting mode	<ul style="list-style-type: none"> <li>• Suitable attachment speed</li> <li>• Lifting capacity is increased 7% by raising hydraulic pressure.</li> </ul>
<b>B</b>	Breaker mode	<ul style="list-style-type: none"> <li>• Optimum engine rpm, hydraulic flow</li> </ul>
<b>ATT</b>	Attachment mode	<ul style="list-style-type: none"> <li>• Optimum engine rpm, hydraulic flow, 2 way</li> </ul>

### Variable Track Gauge (Optional)

- Lateral stability is significantly improved when operating with the gauge extended.
- Lateral stability is increased by 30% (Compared with the fixed gauge version).
- With trackframes retracted, overall width complies with many local transportation regulations.



### Large Digging Force

When press the left knob switch which is called the one-touch power max. switch and when it is kept pressed, this function temporarily increases digging force for 8.5 seconds of operation.

**Maximum arm crowd force (ISO 6015):**  
 200 kN (20.4 t) ➔ **214 kN (21.8 t)** **7% UP**  
 (With Power Max.)

**Maximum bucket digging force (ISO 6015):**  
 256 kN (26.1 t) ➔ **275 kN (28.0 t)** **7% UP**  
 (With Power Max.)

Measured with Power Max. function, 3380 mm arm and ISO 6015 rating.



One-touch power max. switch

### Smooth Loading Operation

Two return hoses improve hydraulic performance. In the arm out function, a portion of the oil is returned directly to the tank providing smooth operation.

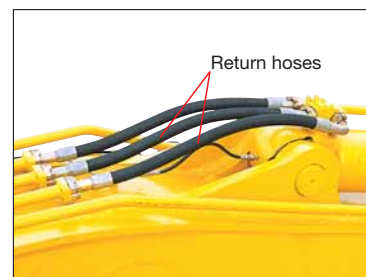

Return hoses

### Two-mode Setting for Boom

Smooth mode provides easy operation for gathering blasted rock or scraping down operation. When maximum digging force is needed, switch to Power mode for more effective excavating.

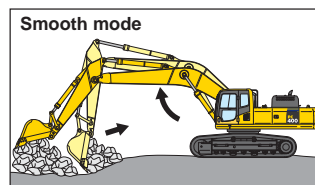

Boom floats upward, reducing lifting of machine front. This facilitates gathering blasted rock and scraping down operations.

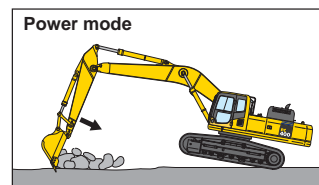

Boom pushing force is increased, ditch digging and box digging operation on hard ground are improved.

# COMFORT



## Low Cab Noise

The newly-designed cab is highly rigid and has excellent sound absorption ability. Thorough improvement of noise source reduction and use of low noise engine, hydraulic equipment, and air conditioner allows this machine to generate a low level of noise.

## Low Vibration with Cab Damper Mounting

PC400-8R uses viscous damper mounting for cab that incorporates longer stroke and the addition of a spring. The new cab damper mounting combined with high rigidity deck aids vibration reduction at operator seat.

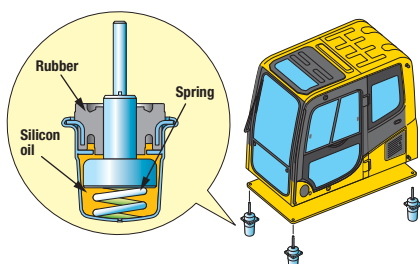

## Wide Newly-designed Cab

Newly-designed wide spacious cab includes seat with reclining backrest. The seat height and longitudinal inclination are easily adjusted using a pull-up lever. You can set the appropriate operational posture of armrest together with the console. Reclining the seat further enables you to place it into the fully flat state with the headrest attached.



## Pressurized Cab

Optional air conditioner (A/C), air filter and a higher internal air pressure minimize external dust from entering the cab.

## Automatic Air Conditioner (A/C) (Optional)

Enables you to easily and precisely set cab atmosphere with the instruments on the large LCD. The bi-level control function keeps the operator's head and feet cool and warm respectively. This improved air flow function keeps the inside of the cab comfortable throughout the year. Defroster function keeps front glass clear.

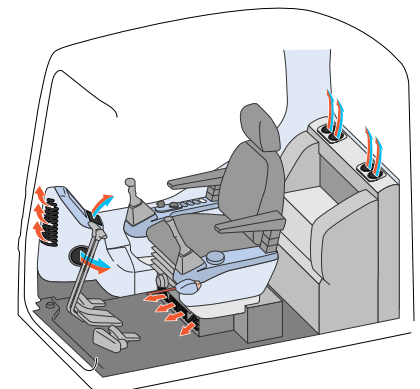

# SAFETY

## ROPS Cab

The machine is equipped with a ROPS cab that conforms to ISO 12117-2 for excavators as standard equipment. The ROPS cab has high shock-absorption performance, featuring excellent durability and impact strength. It also satisfies the requirements of OPG top guard level 1 (ISO 10262) for falling objects. Combined with the retractable seat belt, The ROPS cab protects the operator in case of tipping over and against falling objects.

### ROPS CAB STRUCTURE

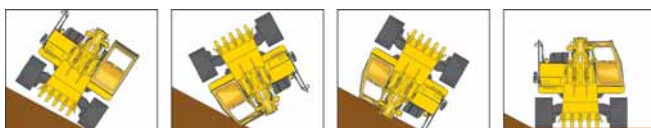
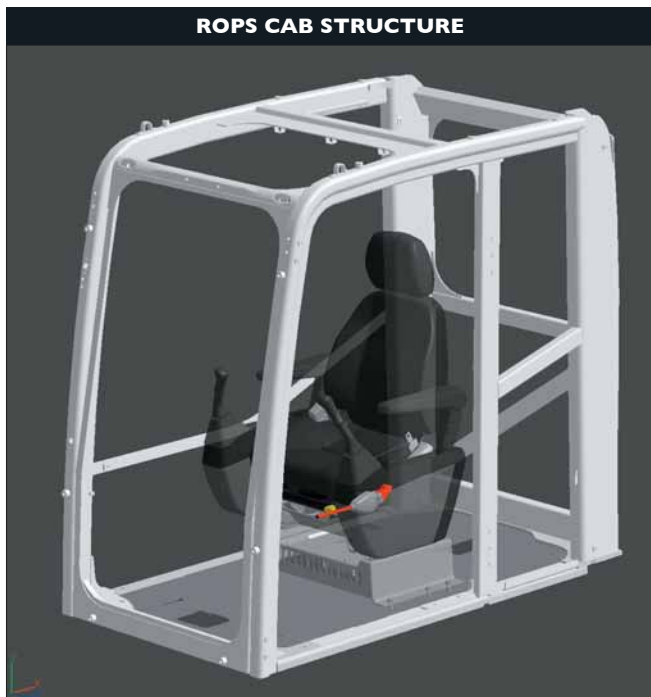

## Slip-resistant Plates

Highly durable slip-resistant plates maintain superior traction performance for the long term.



## Lock Lever

Locks the hydraulic pressure to prevent unintentional movement. Neutral start function allows machine to be started only in lock position.



## Rear View Monitor System (Optional)

The operator can view the rear of the machine with a color monitor screen.



Rear view image on monitor

## Pump/Engine Room Partition

Pump/engine room partition prevents oil from spraying onto the engine if a hydraulic hose should fail.



## Thermal and Fan Guards

Thermal and fan guards are placed around high-temperature parts of the engine and fan drive.



## Large Serrated Steps and Handrail

### Large serrated steps



### Large handrail





## Large Multi-lingual LCD Monitor

A large user-friendly color monitor enables safe, accurate and smooth work. Improved screen visibility is achieved by the use of LCD that can easily be read at various angles and lighting conditions. Simple and easy to operate switches. Function keys facilitate multi-function operations. Displays data in 12 languages to globally support operators around the world.

### Indicators

- |                                  |                                   |
|----------------------------------|-----------------------------------|
| 1 Auto-decelerator               | 5 Hydraulic oil temperature gauge |
| 2 Working mode                   | 6 Fuel gauge                      |
| 3 Travel speed                   | 7 ECO gauge                       |
| 4 Engine water temperature gauge | 8 Function switches menu          |

### Basic operation switches

- |                         |                     |
|-------------------------|---------------------|
| 1 Auto-decelerator      | 4 Buzzer cancel     |
| 2 Working mode selector | 5 Wiper             |
| 3 Traveling selector    | 6 Windshield washer |

## Equipment Management Monitoring System

### Monitor function

Controller monitors engine oil level, coolant temperature, battery charge and air clogging, etc. If controller finds any abnormality, it is displayed on the LCD.



### Maintenance function

Monitor informs replacement time of oil and filters on the LCD when the replacement interval is reached.



### Trouble data memory function

Monitor stores abnormalities for effective troubleshooting.





**Assists Customer's Equipment Management and Contributes to Fuel Cost Cutting**

**Equipment Management Support**

KOMTRAX terminal installed on your machine collects and sends information such as machine location, working record, machine conditions, etc. using wireless communication. You can review the KOMTRAX data remotely via the online application. KOMTRAX not only gives you the informations on your machine, but also the convenience of managing your fleet on the Web.

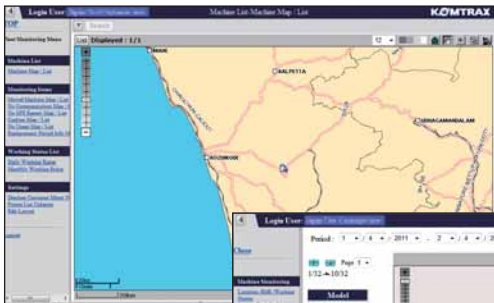

Location

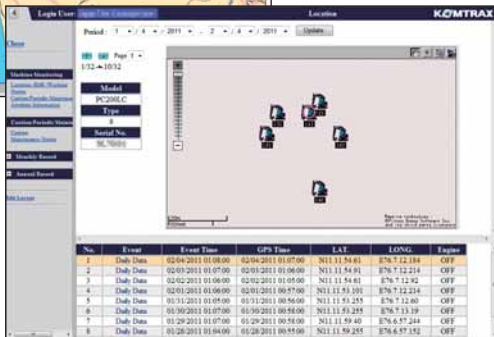

Movement generated position



Operation map

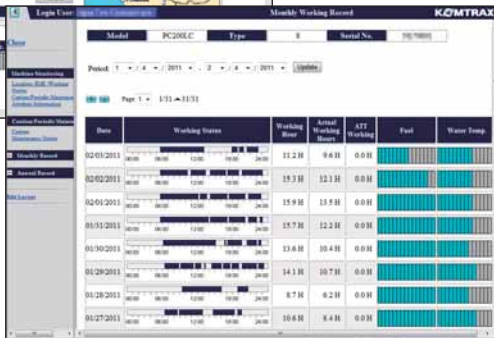

Monthly status summary

**Energy-saving Operation Support Report**

KOMTRAX can provide various useful information which includes the energy-saving operation support report created based on the operating information of your machine such as fuel consumption and idle time.

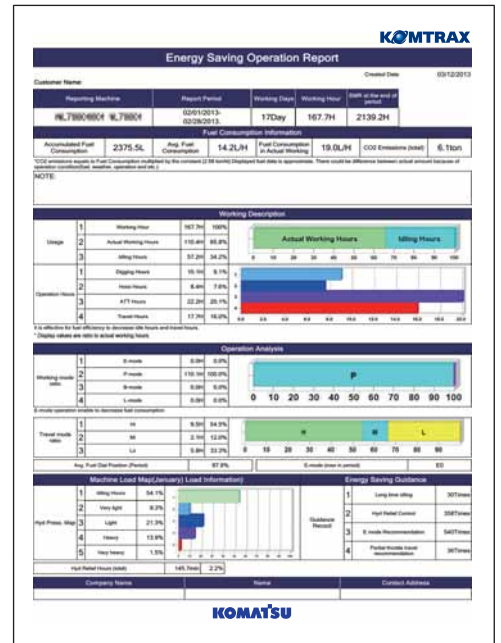

Image

# MAINTENANCE

## Easy Access to Engine Oil Filter and Fuel Drain Valve

Engine oil dipstick and fill, and fuel filter are mounted on same side to improve accessibility. Fuel drain valve are remotely mounted to improve accessibility.



Fuel drain valve

## Electric Priming Pump

Bleeding air from fuel system is easily accomplished with the electric priming pump.



Electric priming pump switch

## Easy Radiator Cleaning

Since radiator and oil cooler are arranged side-by-side, it is easy to clean, remove and install them.

## Large-size Steps

On both right and left track frames are fixed with wider steps for easier maintenance.



## Large Capacity Air Cleaner

Large capacity air cleaner is comparable to that of larger machines. The larger air cleaner can extend air cleaner life during long-term operation and prevents early clogging and resulting power decrease. Reliability is improved by a new seal design.



## Long-life Oil, Filter

Uses high-performance filtering materials and long-life oil. Extends the oil and filter replacement interval.



Hydraulic oil filter

<b>Engine oil &amp; Engine oil filter</b>	every <b>500</b> hours
<b>Hydraulic oil</b>	every <b>5000</b> hours
<b>Hydraulic oil filter</b>	every <b>1000</b> hours

## Long Work Equipment Greasing Interval (Optional)

High quality bushings and resin shims are optionally available for work equipment pins excluding bucket, extending greasing interval to 500 hours.

## Large Fuel Tank Capacity

Large fuel tank capacity extends operating hours before refueling. Fuel tank is treated for rust prevention and improved corrosion resistance.



# RELIABILITY

## High Pressure In-line Filter

In-line filters are provided at outlet port (Pressure side) of each pump to protect hydraulic system contamination.

In-line filters



## Fuel Main-filter

The reliability of fuel systems is improved, because fuel main-filter removes contamination and sludge contained in fuel.



## Metal Guard Rings

Metal guard rings protect all the hydraulic cylinders and improve reliability.

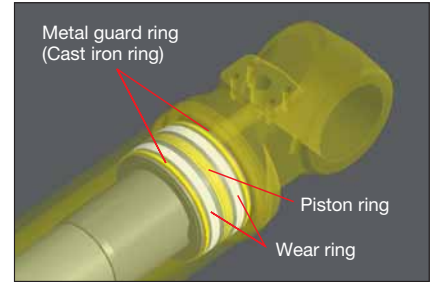

## Equipped with Fuel Pre-filter (With Water Separator)

Removes water and contaminants in the fuel to prevent fuel problems.



## Water Separator

Removes water from the fuel and improves the reliability of fuel systems.



## Shield Connectors

Shield connectors seal tight and have higher reliability.

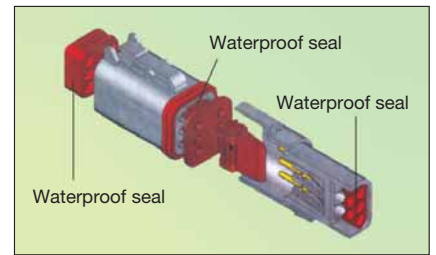

# OPTIONS

- Cab front full height guard level 1 (ISO 10262)



- Cab front full height guard level 2 (ISO 10262)



- Additional front lights
- Rain visor



- Air pre-cleaner



- OPG top guard level 2 (ISO 10262)



- Strengthened track frame undercover



- Sun visor



- Seat, suspension



# KOMATSU BRAND BUCKET

## KOMATSU Brand Bucket for General Purpose with Wide Bucket Width

### Me Bucket

- Low resistant excavation
- High productivity
- High durability
- High fuel efficiency

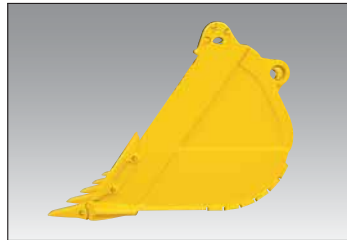

Conventional



Me Bucket

### Category and Feature

Category	Load / Wear / Soil (Application)	Image
<b>Light Duty</b> LD	<p><b>Load</b> Machine power remains low during the majority of the work. No impact load.</p> <p><b>Wear</b> Material is not abrasive.</p> <p><b>Soil</b> Dirt, loam and clay.</p>	
<b>General Purpose</b> GP	<p><b>Load</b> Machine power is mostly medium, but occasionally high. Bucket movements are smooth with minor shock load. Bucket penetrates easily.</p> <p><b>Wear</b> Material is lightly abrasive. Some sand may be medium abrasive.</p> <p><b>Soil</b> Mostly loose sand, gravel and finely broken materials.</p>	
<b>Heavy Duty</b> HD	<p><b>Load</b> Machine power is high during majority of the work. Medium, but continuous shock load.</p> <p><b>Wear</b> Material is abrasive. Light scratch marks can be seen at the bucket.</p> <p><b>Soil</b> Limestone, shot rock, compact mix of sand, gravel and clay.</p>	
<b>Extra Heavy Duty</b> XHD	<p><b>Load</b> Machine power is high during most of the work, often at maximum. Dynamic shock loads are frequent and machine may shake.</p> <p><b>Wear</b> Material is very abrasive. Large scratch marks are visible and, or deform metal. Works within heaps of rock with occasional un-shot rock and rock boulders.</p> <p><b>Soil</b> Granite, basalt, quartz sand, compact and sticky clay.</p>	

### Bucket Line-up

Category	Bucket Type	Capacity (m³)	Width*1 (mm)	Weight*2 (kg)	Tooth Quantity	Boom + Arm (m)					Tooth Type			
						7.06+2.40	7.06+2.90	7.06+3.38	7.06+4.00	6.67+2.40 SE Spec.	Vertical	Horizontal	PAB*3	KMAX
LD	Conventional	2.20	— <1715>	1395	5	●	●	●	×	—	✓	✓	✓	✓
GP	Conventional	1.30	1270 <1120>	1115	4	○	○	○	○	—	✓			
		1.60	1420 <1270>	1197	5	○	○	○	○	—		✓	✓	
		1.90	1625 <1475>	1358	5	○	○	○	□	—		✓	✓	
		2.06	1715 <1565>	1391	5	□	□	□	■	—		✓	✓	✓
		2.80	1715 <1565>	1680	5	×	×	×	×	○	✓			
HD	Conventional	1.90	1625 <1475>	1965	5	○	○	○	×	—		✓	✓	✓
	Me Bucket	1.90	1625 <1475>	2025	5	○	○	○	×	—		✓	✓	✓
XHD	Me Bucket	1.90	1625 <1475>	2069	5	☆	○	○	×	—		✓	✓	

\*1 With side cutters or side shrouds, < > without side cutters or side shrouds \*2 With side cutters \*3 PAB: Pin And Bushing system

☆: Heavy duty work, density up to 2.1 t/m³ ○: General purpose use, density up to 1.8 t/m³ □: General purpose use, density up to 1.5 t/m³ ●: Light duty work, density up to 1.2 t/m³

■: Light duty work, density up to 0.9 t/m³ ×: Not usable ✓: Selectable

**Feature of [Me Bucket] (More suitable shape and Effectiveness Bucket)**

**High Productivity by Low-resistant Excavation**

The new Ideal bucket profile produces lower resistance at inside & outside bucket and production will be greatly increased.

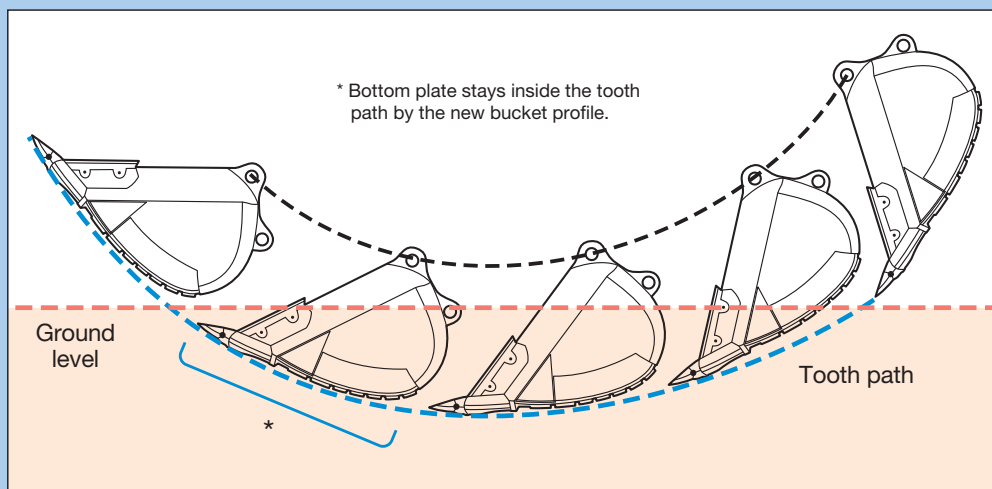

**Feature of [PAB Tooth] (Pin And Bushing system Tooth)**

- Able to fit on the bucket with horizontal pin type adapter
  - Easy change-out only with a ratchet wrench
  - Longer tooth life by easy rotation and turnover
  - Durable and reusable PAB pin with flat surface
- Limited to where horizontal pin type tooth is mainly used.

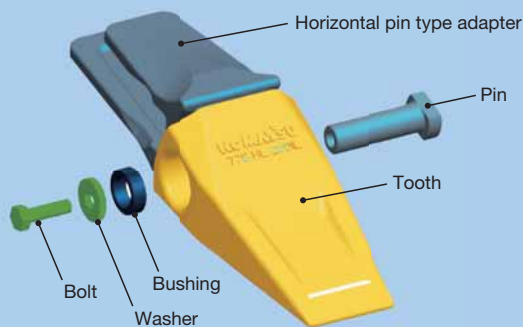

Set PAB tooth to horizontal pin type adapter



Insert exclusive pin to the adapter pin hole



Set bushing, washer and bolt and tighten by a ratchet wrench

**■ PAB Tooth Line-up**



Type	Style
Integrated Long Life IL	
Heavy Standard HS	
Heavy Rock HR	
Self Sharp SYL	
Hybrid HB	

**■ Applicable Working Site**

Application	Soil	Tight Material ←————→ Loose Material			
		Soiled Rock	Broken Rock	Clay	Gravel Sand
Extreme Heavy Excavation	<b>HB</b> Hybrid				
Havy Excavation	<b>HR</b> Heavy rock				
General Application	<b>HS</b> Heavy standard				
	<b>SYL</b> Self sharp				
Loading/Unloading					

## Special Purpose Bucket & Ripper

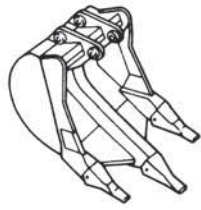
### ■ Feature and Specifications

Type	Feature	Bucket Capacity (SAE J 296 Heaped)	Width	Image
<b>Ripper Bucket</b>	Suitable for digging rock bed or hard clayey soil when normal buckets cannot penetrate deep enough. Loading is also possible.	1.10 m <sup>3</sup>	1250 mm	
<b>Single-shank Ripper</b>	This ripper is used for site preparation prior to digging work, when it becomes necessary to remove rocks, pavement for other obstacles. Also effective for pulling out tree stumps.	—	—	



# HENSLEY BRAND BUCKET

## Diverse Bucket Capacity by Application Featuring "KMAX" Tooth System



- Wide range selection for each application
- Larger profile and capacity to maximize production
- Multiple width options to meet specific job requirements and reduce backfill

### Category and Recommended Applications

Category	Recommended Applications	Image
<b>Trenching and Loading TL</b>	Dirt, loam, sand, gravel, loose clay, abrasive soils with limited rock mixture.	
<b>Heavy Duty Plate Lip Bucket with Wear Plate HP</b>	Abrasive soils, compact or dense clay, loose rock and gravel.	
<b>Heavy Duty Plate Lip Bucket with Wear Plate &amp; Wear Strips HPS</b>	Abrasive soils, compact or dense clay, loose rock and gravel.	
<b>Extreme Duty Plate Lip Bucket with Special Features HPX</b>	Shot rock, stratified materials, quarry or tough, highly abrasive applications.	

### Bucket Line-up

Category	Capacity (m³)	Width (mm)	Weight (kg)	Tooth Quantity	Boom + Arm (m)				Tooth Type
					7.06+2.40	7.06+2.90	7.06+3.38	7.06+4.00	
TL	1.12	762	1291	3	☆	☆	☆	☆	✓
	1.35	914	1444	4	☆	☆	☆	☆	✓
	1.64	1067	1565	4	☆	☆	☆	☆	✓
	1.94	1219	1724	5	☆	☆	☆	□	✓
	2.25	1372	1912	6	○	○	○	●	✓
	2.55	1524	2012	6	□	□	●	●	✓
	2.87	1676	2171	7	●	■	■	■	✓
HP	1.12	762	1488	3	☆	☆	☆	☆	✓
	1.35	914	1677	4	☆	☆	☆	☆	✓
	1.64	1067	1818	4	☆	☆	☆	□	✓
	1.94	1219	1994	5	○	○	○	○	✓
	2.25	1372	2170	6	○	□	□	●	✓
	2.55	1524	2540	6	□	●	●	■	✓
	2.87	1676	2764	7	●	■	■	■	✓
HPS	1.12	762	1583	3	☆	☆	☆	☆	✓
	1.35	914	1790	4	☆	☆	☆	☆	✓
	1.64	1067	1952	4	☆	☆	☆	○	✓
	1.94	1219	2143	5	○	○	□	□	✓
	2.25	1372	2342	6	○	□	●	●	✓
	2.55	1524	2729	6	□	●	■	■	✓
	2.87	1676	2973	7	●	■	■	■	✓
HPX	1.12	762	1774	3	☆	☆	☆	☆	✓
	1.35	914	2019	4	☆	☆	☆	☆	✓
	1.64	1067	2192	4	☆	☆	☆	○	✓
	1.94	1219	2412	5	○	○	□	●	✓
	2.25	1372	2643	6	□	●	■	■	✓
	2.55	1524	2903	6	●	●	■	■	✓
	2.87	1676	2989	7	■	■	■	■	✓

☆: Heavy duty work, density up to 2.1 t/m³ ○: General purpose use, density up to 1.8 t/m³  
 □: General purpose use, density up to 1.5 t/m³ ●: Light duty work, density up to 1.2 t/m³  
 ■: Light duty work, density up to 0.9 t/m³ ×: Not usable ✓: Selectable

### Feature of KMAX Tooth System

- Better penetration and cycle times
- Hardness throughout the tooth
- Unique high strength design
- Unique reusable fastener
- Less "throw away" waste
- Fast tooth changeover



#### Tooth

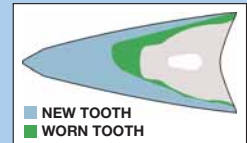

The KMAX RC style tooth shown here offers a consumption ratio of 60%.

#### Fastener

Simple, reusable fastener system saves time and money by unlocking with a simple 90-degree turn.



To lock, use the correct size socket, rotate the pin locking shaft 90-degree clockwise to finish the installation.



When removing the fastener, use the correct size socket to rotate the pin-locking shaft 90-degree counter-clockwise.

### KMAX Tooth Line-up

Feature	Style
<b>F Flare:</b> Loose material for clean bottom and greater fill	
<b>SYL Standard:</b> General applications	
<b>SD Chisel:</b> General purpose tooth Designed for penetration	
<b>RC Rock Chisel:</b> Designed for penetration and long wear life	
<b>T Tiger:</b> Designed for good penetration with ribs for strength	
<b>TV Tiger:</b> Offers best penetration in tight material	
<b>UT Twin Tiger:</b> Offers longer life penetration for corners	
<b>WT Twin Tiger:</b> Designed for penetration for corners	

Some application may not have been available in your country or region. If you are interested in such application, please contact a KOMATSU office near you.

# SPECIAL SPECS.

## Attachment Piping Specification

Equips PC400-8R for breaker and crusher installation. Hydraulic flow rate can be regulated by setting Breaker Mode on monitor panel during breaker operation.



## Super Long Front

Super long front attachment boasts a huge digging reach. An excavator with this attachment highly improves working efficiency in various works such as river conservation, lake dredging, slopefinishing and materials carrying where an extensively long reach is required.

### Specifications

	PC400LC-8R
Reach	19.7 m
Max. Bucket Capacity (SAE J 296 Heaped)	0.8 m <sup>3</sup>
Boom Length	11.1 m
Arm Length	8.3 m

### Working Range

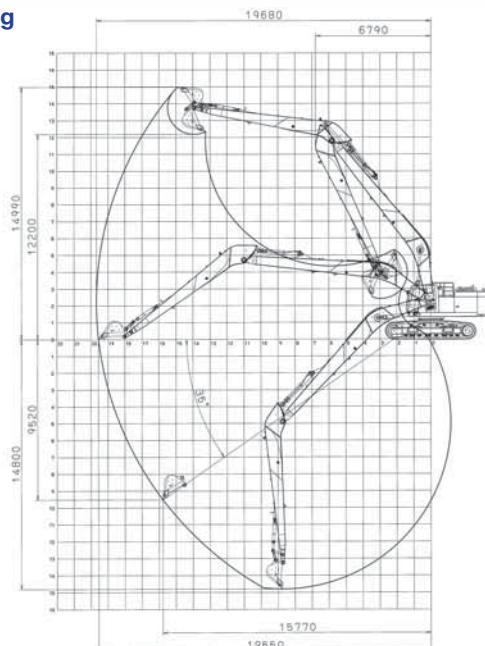



# ATTACHMENT

## Komatsu Genuine Attachment Tool

Komatsu-recommended attachment tools for hydraulic excavators  
A wide range of attachment tools are provided to suit customers' specific applications.

### Hydraulic breaker

The hydraulic breaker is an attachment tool used for crushing rock beds and paved surfaces, demolishing concrete structures, etc. The large gas chamber, ideal gas pressure ratio, and long-stroke piston deliver a powerful impact force. Since the breaker unit does not require an accumulator, the number of parts has been reduced, resulting in lower maintenance costs.



### Crusher

This attachment tool is used for demolishing concrete structures. Since it does not have a striking mechanism and features low noise and low vibration, it is suitable for work in urban areas. The open-close cylinder is equipped with a speed-up valve for increasing work speed.



Primary crusher



Pulverizer



### Scrap & demolition shear

The scrap & demolition shears have multiple applications for both overhead-demolishing the steel structure (General structural steels) and cutting structural steel with required length at ground level. (In foundries, dumps, scrap yards)



## Applications of Attachment Tools

Application/ Attachment Tool	Civil Engineering	Quarry	Demolition	Industrial Waste Disposal	Iron-making	Utility Construction	Rental
Hydraulic Breaker	○	○	○	○	○	○	○
Crusher (Primary Crusher)			○				○
Crusher (Pulverizer)			○	○			○
Scrap & Demolition Shear			○	○			○

# KOMATSU TOTAL SUPPORT



## Komatsu Total Support

To keep your machine available and minimize operation cost when you need it, Komatsu Distributor is ready to provide variety of support before and after procuring the machine.

### Fleet recommendation

Komatsu Distributor can study customer job site and provide the most optimum fleet recommendation with detailed information to meet all of your application needs when you are considering to buy new machines or to replace the existing ones from Komatsu.



### Product support

Komatsu Distributor secure the certain quality of machine will be delivered.

### Parts availability

Komatsu Distributor is available for emergency inquiry by the customers for genuine, quality guaranteed Komatsu parts.

### Technical support

Komatsu product support service (Technical support) are designed to help customer. Komatsu Distributor offers a variety of effective services how much Komatsu is dedicated to the maintenance and support of Komatsu machine.

- Preventive Maintenance (PM) clinic
- Oil & Wear analysis program
- Undercarriage inspection service, etc.



### Repair & maintenance service

Komatsu Distributor offers quality repair service, periodical maintenance, and maintenance service to the customer, utilizing and promoting Komatsu developed programs.

### Komatsu Reman (Remanufactured) components

Komatsu Reman products are the result of the implementation of the Komatsu global Reman policy which establishes and agrees to reduce the owning, operating and total Life Cycle Costs (LCC) to Komatsu's customer through prompt delivery, high quality and competitively priced in own remanufactured products (QDC).



# SPECIFICATIONS



## ENGINE

Model ..... Komatsu SAA6D125E-5  
 Type ..... Water-cooled, 4-cycle, direct injection  
 Aspiration ..... Turbocharged, aftercooled  
 Number of cylinders ..... 6  
 Bore ..... 125 mm  
 Stroke ..... 150 mm  
 Piston displacement ..... 11.04 L  
 Horsepower:  
   SAE J1995 ..... Gross 270 kW 362 HP  
   ISO 9249 / SAE J1349 ..... Net 257 kW 345 HP  
   Rated rpm ..... 1900 min<sup>-1</sup>  
 Fan drive method for radiator cooling ..... Mechanical  
 Governor ..... All-speed control, electronic

U.S. EPA Tier 2 and EU Stage 2 emissions equivalent.



## HYDRAULICS

Type .. HydraMind (Hydraulic Mechanical Intelligence New Design) system, closed-center system with load sensing valves and pressure compensated valves  
 Number of selectable working modes ..... 4  
 Main pump:  
   Type ..... Variable displacement piston type  
   Pumps for ..... Boom, arm, bucket, swing, and travel circuits  
   Maximum flow ..... 690 L/min  
   Supply for control circuit ..... Self-reducing valve  
 Hydraulic motors:  
   Travel ..... 2 x axial piston motor with parking brake  
   Swing ..... 1 x axial piston motor with swing holding brake  
 Relief valve setting:  
   Implement circuits ..... 37.3 MPa 380 kg/cm<sup>2</sup>  
   Travel circuit ..... 37.3 MPa 380 kg/cm<sup>2</sup>  
   Swing circuit ..... 27.9 MPa 285 kg/cm<sup>2</sup>  
   Pilot circuit ..... 3.2 MPa 33 kg/cm<sup>2</sup>  
 Hydraulic cylinders:  
 (Number of cylinders – bore x stroke x rod diameter)  
   Boom ..... 2–160 mm x 1570 mm x 110 mm  
   Arm  
     Std except 2.4 m arm ..... 1–185 mm x 1820 mm x 120 mm  
     for 2.4 m arm ..... 1–185 mm x 1590 mm x 120 mm  
   SE ..... 1–185 mm x 1820 mm x 120 mm  
   Bucket  
     Std ..... 1–160 mm x 1270 mm x 110 mm  
     SE ..... 1–185 mm x 1160 mm x 120 mm



## DRIVES AND BRAKES

Steering control ..... Two levers with pedals  
 Drive method ..... Hydrostatic  
 Maximum drawbar pull ..... 330 kN 33700 kg  
 Gradeability ..... 70%, 35°  
 Maximum travel speed: High ..... 5.5 km/h  
 (Auto-shift) Mid ..... 4.0 km/h  
 (Auto-shift) Low ..... 3.0 km/h  
 Service brake ..... Hydraulic lock  
 Parking brake ..... Mechanical disc brake



## SWING SYSTEM

Drive method ..... Hydrostatic  
 Swing reduction ..... Planetary gear  
 Swing circle lubrication ..... Grease-bathed  
 Service brake ..... Hydraulic lock  
 Holding brake/Swing lock ..... Mechanical disc brake  
 Swing speed ..... 9.1 min<sup>-1</sup>



## UNDERCARRIAGE

Center frame ..... X-frame  
 Track frame ..... Box-section  
 Seal of track ..... Sealed track  
 Track adjuster ..... Hydraulic  
 Number of shoes (Each side):  
   PC400-8R ..... 46  
   PC400LC-8R ..... 49  
 Number of carrier rollers (Each side) ..... 2  
 Number of track rollers (Each side):  
   PC400-8R ..... 7  
   PC400LC-8R ..... 8



## COOLANT AND LUBRICANT CAPACITY (REFILLING)

Fuel tank ..... 650 L  
 Coolant ..... 36.0 L  
 Engine ..... 37.0 L  
 Final drive (Each side) ..... 10.5 L  
 Swing drive ..... 20.0 L  
 Hydraulic tank ..... 248 L



## OPERATING WEIGHT (APPROXIMATE)

Operating weight including 7060 mm one-piece boom, 3380 mm arm, ISO 7451 heaped 1.90 m<sup>3</sup> backhoe bucket, rated capacity of lubricants, coolant, full fuel tank, operator, and standard equipment.

Shoes	PC400-8R		PC400LC-8R	
	Operating Weight	Ground Pressure	Operating Weight	Ground Pressure
600 mm	41740 kg	77.8 kPa 0.79 kg/cm <sup>2</sup>	42290 kg	73.3 kPa 0.75 kg/cm <sup>2</sup>
700 mm	42160 kg	67.3 kPa 0.69 kg/cm <sup>2</sup>	42740 kg	63.5 kPa 0.65 kg/cm <sup>2</sup>
800 mm	42590 kg	59.5 kPa 0.61 kg/cm <sup>2</sup>	43200 kg	56.2 kPa 0.57 kg/cm <sup>2</sup>

Operating weight including 6670 mm one-piece boom, 2400 mm arm, ISO 7451 heaped 2.80 m<sup>3</sup> backhoe bucket, rated capacity of lubricants, coolant, full fuel tank, operator, and standard equipment.

Shoes	PC400-8R SE Spec.		PC400LC-8R SE Spec.	
	Operating Weight	Ground Pressure	Operating Weight	Ground Pressure
600 mm	42020 kg	78.3 kPa 0.80 kg/cm <sup>2</sup>	42570 kg	73.8 kPa 0.75 kg/cm <sup>2</sup>



## DIMENSIONS & WORKING RANGE

Model	PC400-8R / PC400LC-8R				PC400-8R SE Spec. / PC400LC-8R SE Spec.	
<b>Boom Length</b>	<b>7060 mm</b>				<b>6670 mm</b>	
<b>Arm Length</b>	<b>2400 mm</b>	<b>2900 mm</b>	<b>3380 mm</b>	<b>4000 mm</b>	<b>2400 mm</b>	
<b>A</b> Overall length	11905 mm	11995 mm	11940 mm	11950 mm	11635 mm	
<b>B</b> Length on ground (Transport)	8230 mm / 8410 mm	7290 mm / 7475 mm	6540 mm / 6705 mm	6145 mm / 6330 mm	7860 mm	
<b>C</b> Overall height (To top of boom)*	3850 mm	3745 mm	3635 mm	3885 mm	3665 mm	
<b>D</b> Overall width	3430 mm / 3440 mm				3430 mm	
<b>E</b> Overall height (To top of cab)*	3285 mm				3285 mm	
<b>F</b> Ground clearance, counterweight	1320 mm				1320 mm	
<b>G</b> Ground clearance (Minimum)	555 mm / 550 mm				550 mm	
<b>H</b> Tail swing radius	3645 mm				3645 mm	
<b>I</b> Track length on ground	4020 mm / 4350 mm				4020mm / 4350 mm	
<b>J</b> Track length	5055 mm / 5385 mm				5055mm / 5385 mm	
<b>K</b> Track gauge	2740 mm				2740 mm	
<b>L</b> Width of crawler	3340 mm / 3440 mm				3340 mm	
<b>M</b> Shoe width	600 mm / 700 mm				600 mm	
<b>N</b> Grouser height	37 mm				37 mm	
<b>O</b> Machine cab height	2920 mm				2920 mm	
<b>P</b> Machine cab width	3090 mm				3165 mm	
<b>Q</b> Distance, swing center to rear end	3605 mm				3605 mm	
<b>R</b> Max. digging height	10310 mm	10285 mm	10915 mm	11025 mm	10155 mm	
<b>S</b> Max. dumping height	7070 mm	7080 mm	7565 mm	7715 mm	6605 mm	
<b>T</b> Max. digging depth	6845 mm	7345 mm	7820 mm	8445 mm	6740 mm	
<b>U</b> Max. vertical wall digging depth	5305 mm	5700 mm	6870 mm	7285 mm	3810 mm	
<b>V</b> Max. digging depth of cut for 2440 mm level	6650 mm	7155 mm	7680 mm	8315 mm	6570 mm	
<b>W</b> Max. digging reach	11080 mm	11445 mm	12025 mm	12565 mm	10975 mm	
<b>X</b> Max. digging reach at ground level	10855 mm	11230 mm	11820 mm	12365 mm	10750 mm	
<b>Y</b> Min. swing radius	4835 mm	4810 mm	4735 mm	4800 mm	4470 mm	
<b>SAE 1179 Rating</b>	Bucket digging force at power max.	241 kN 24600 kg	240 kN 24500 kg	239 kN 24400 kg	239 kN 24400 kg	280 kN 28600 kg
	Arm crowd force at power max.	241 kN 24600 kg	245 kN 25000 kg	205 kN 20900 kg	184 kN 18800 kg	260 kN 26600 kg
<b>ISO 6015 Rating</b>	Bucket digging force at power max.	277 kN 28200 kg	276 kN 28100 kg	275 kN 28000 kg	270 kN 27500 kg	308 kN 31400 kg
	Arm crowd force at power max.	254 kN 25900 kg	257 kN 26200 kg	214 kN 21800 kg	190 kN 19400 kg	269 kN 27400 kg

\* Including grouser height

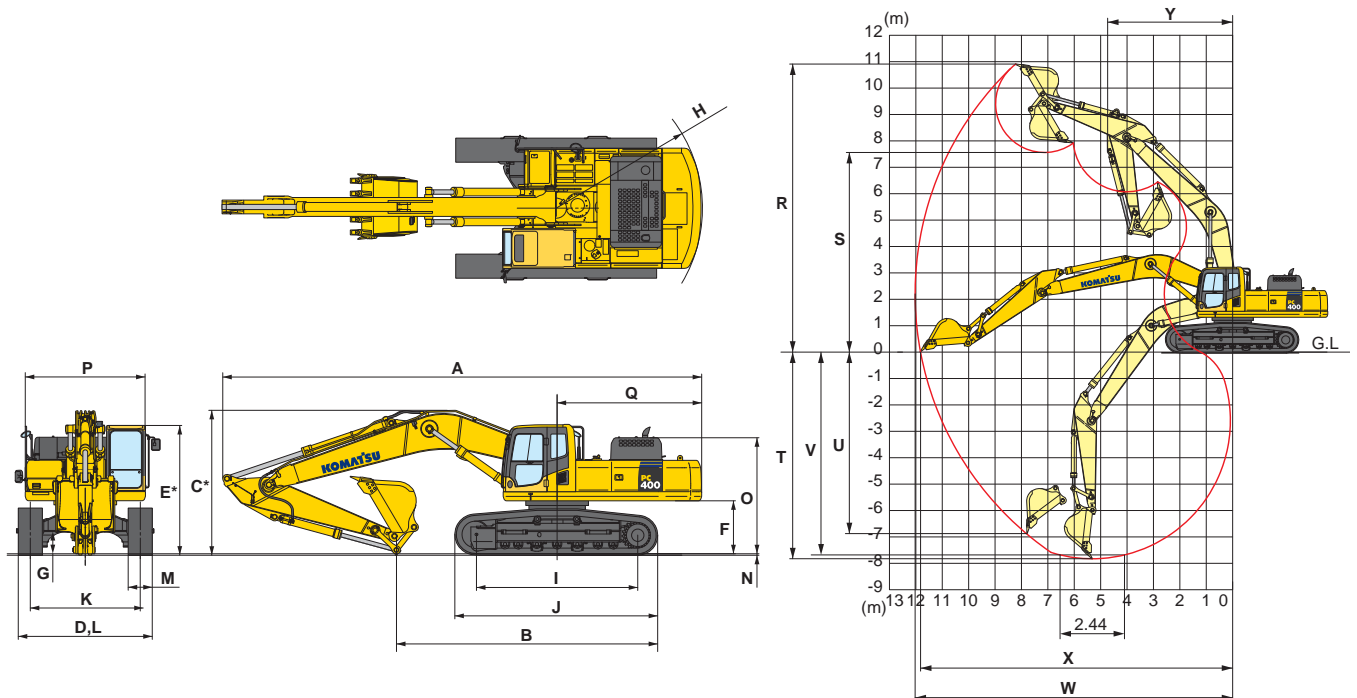



**LIFTING CAPACITY WITH LIFTING MODE**

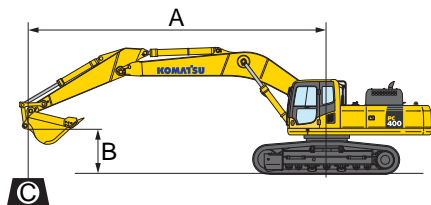

**PC400-8R**

- A: Reach from swing center
- B: Bucket hook height
- C: Lifting capacity
- Cf: Rating over front
- Cs: Rating over side
- ☉: Rating at maximum reach

PC400-8R Boom: 7060 mm Arm: 2400 mm Bucket: 1.90 m <sup>3</sup> ISO 7451 heaped Shoe: 600 mm triple grouser													
B	A	☉ MAX		9.0 m		7.5 m		6.0 m		4.5 m		3.0 m	
		Cf	Cs	Cf	Cs	Cf	Cs	Cf	Cs	Cf	Cs	Cf	Cs
7.5m		*11050 kg	7950 kg			*11050 kg	8450 kg						
6.0m		9650 kg	6450 kg			*11400 kg	8250 kg	*13150 kg	12050 kg				
4.5m		8550 kg	5650 kg	8750 kg	5800 kg	11850 kg	7900 kg	*15150 kg	11350 kg				
3.0m		8000 kg	5250 kg	8550 kg	5600 kg	11450 kg	7550 kg	16450 kg	10650 kg				
1.5m		7850 kg	5100 kg	8350 kg	5450 kg	11150 kg	7250 kg	15850 kg	10150 kg				
0m		8100 kg	5250 kg	8250 kg	5300 kg	10900 kg	7050 kg	15550 kg	9850 kg				
-1.5m		8800 kg	5700 kg	8250 kg	5300 kg	10850 kg	7000 kg	15500 kg	9800 kg	*18450 kg	15600 kg		
-3.0m		10350 kg	6700 kg			10950 kg	7100 kg	*15600 kg	9950 kg	*19150 kg	16000 kg	*18450 kg	*18450 kg
-4.5m		*10500 kg	9000 kg					*12200 kg	10250 kg	*15150 kg	*15150 kg		

PC400-8R Boom: 7060 mm Arm: 2900 mm Bucket: 1.90 m <sup>3</sup> ISO 7451 heaped Shoe: 600 mm triple grouser													
B	A	☉ MAX		9.0 m		7.5 m		6.0 m		4.5 m		3.0 m	
		Cf	Cs	Cf	Cs	Cf	Cs	Cf	Cs	Cf	Cs	Cf	Cs
7.5m		*10050 kg	7200 kg			*10100 kg	8500 kg						
6.0m		8900 kg	5900 kg	8850 kg	5900 kg	*10650 kg	8250 kg						
4.5m		7900 kg	5150 kg	8650 kg	5700 kg	*11600 kg	7900 kg	*14150 kg	11400 kg	*18550 kg	18200 kg		
3.0m		7400 kg	4750 kg	8450 kg	5500 kg	11400 kg	7450 kg	*16300 kg	10650 kg				
1.5m		7250 kg	4650 kg	8200 kg	5300 kg	11000 kg	7100 kg	15750 kg	10000 kg				
0m		7400 kg	4700 kg	8050 kg	5150 kg	10750 kg	6850 kg	15350 kg	9650 kg				
-1.5m		8000 kg	5100 kg	8000 kg	5100 kg	10600 kg	6750 kg	15200 kg	9500 kg	*22,650 kg	15250 kg		
-3.0m		9250 kg	5900 kg			10650 kg	6800 kg	15300 kg	9600 kg	*20350 kg	15450 kg	*22050 kg	*22050 kg
-4.5m		*10550 kg	7700 kg			*9350 kg	7050 kg	*13300 kg	9900 kg	*16700 kg	15650 kg	*19650 kg	*19650 kg

PC400-8R Boom: 7060 mm Arm: 3380 mm Bucket: 1.90 m <sup>3</sup> ISO 7451 heaped Shoe: 600 mm triple grouser													
B	A	☉ MAX		9.0 m		7.5 m		6.0 m		4.5 m		3.0 m	
		Cf	Cs	Cf	Cs	Cf	Cs	Cf	Cs	Cf	Cs	Cf	Cs
7.5m		*6800 kg	6250 kg										
6.0m		*6800 kg	5250 kg	9050 kg	6100 kg	*10150 kg	8500 kg						
4.5m		*7000 kg	4700 kg	8850 kg	5900 kg	*11200 kg	8100 kg	*13450 kg	11750 kg				
3.0m		6750 kg	4350 kg	8600 kg	5650 kg	11650 kg	7700 kg	*15750 kg	11000 kg	*21600 kg	17150 kg		
1.5m		6600 kg	4250 kg	8350 kg	5450 kg	11200 kg	7300 kg	16100 kg	10300 kg	*16950 kg	15850 kg		
0m		6750 kg	4300 kg	8150 kg	5250 kg	10900 kg	7050 kg	15600 kg	9850 kg	*17000 kg	15350 kg		
-1.5m		7200 kg	4600 kg	8050 kg	5150 kg	10750 kg	6850 kg	15350 kg	9650 kg	*22,700 kg	15350 kg		
-3.0m		8150 kg	5250 kg	8100 kg	5200 kg	10700 kg	6850 kg	15400 kg	9700 kg	*21800 kg	15500 kg	*18600 kg	*18600 kg
-4.5m		*9850 kg	6500 kg			10850 kg	7000 kg	*14500 kg	9900 kg	*18550 kg	15850 kg	*23300 kg	*23300 kg
-6.0m		*8800 kg	*8800 kg					*10150 kg	*10150 kg	*13350 kg	*13350 kg		

PC400-8R Boom: 7060 mm Arm: 4000 mm Bucket: 1.60 m <sup>3</sup> ISO 7451 heaped Shoe: 600 mm triple grouser															
B	A	☉ MAX		10.5 m		9.0 m		7.5 m		6.0 m		4.5 m		3.0 m	
		Cf	Cs	Cf	Cs	Cf	Cs	Cf	Cs	Cf	Cs	Cf	Cs	Cf	Cs
7.5m		*5850 kg	5600 kg			*8550 kg	6350 kg								
6.0m		*5800 kg	4800 kg			*8800 kg	6250 kg								
4.5m		*6000 kg	4300 kg	6800 kg	4450 kg	9000 kg	6000 kg	*10500 kg	8300 kg						
3.0m		6250 kg	4000 kg	6650 kg	4350 kg	8700 kg	5750 kg	*11800 kg	7850 kg	*14700 kg	11250 kg	*20750 kg	17700 kg		
1.5m		6100 kg	3900 kg	6500 kg	4200 kg	8400 kg	5500 kg	11300 kg	7400 kg	16250 kg	10450 kg	*23300 kg	16150 kg		
0m		6200 kg	3950 kg	6400 kg	4050 kg	8200 kg	5250 kg	10950 kg	7050 kg	15650 kg	9900 kg	*20450 kg	15350 kg		
-1.5m		6550 kg	4150 kg	6300 kg	4000 kg	8050 kg	5150 kg	10700 kg	6850 kg	15300 kg	9600 kg	*23250 kg	15050 kg	*11150 kg	*11150 kg
-3.0m		7300 kg	4650 kg			8000 kg	5100 kg	10600 kg	6750 kg	15200 kg	9500 kg	*22850 kg	15150 kg	*19200 kg	*19200 kg
-4.5m		8750 kg	5600 kg					10700 kg	6850 kg	15300 kg	9650 kg	*20200 kg	15400 kg	*24850 kg	*24850 kg
-6.0m		*9150 kg	7650 kg					*8250 kg	7150 kg	*12250 kg	10000 kg	*15850 kg	15750 kg	*20300 kg	*20300 kg

\* Load is limited by hydraulic capacity rather than tipping. Ratings are based on SAE J1097. Rated loads do not exceed 87% of hydraulic lift capacity or 75% of tipping load.



## LIFTING CAPACITY WITH LIFTING MODE

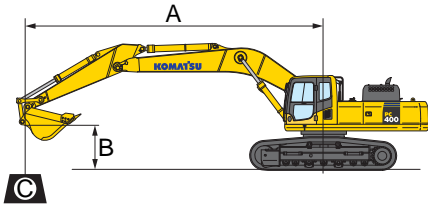

### PC400LC-8R

- A: Reach from swing center
- B: Bucket hook height
- C: Lifting capacity
- Cf: Rating over front
- Cs: Rating over side
- ☉: Rating at maximum reach

PC400LC-8R		Boom: 7060 mm		Arm: 2400 mm		Bucket: 1.90 m <sup>3</sup> ISO 7451 heaped		Shoe: 700 mm triple grouser					
B	A	☉ MAX		9.0 m		7.5 m		6.0 m		4.5 m		3.0 m	
		Cf	Cs	Cf	Cs	Cf	Cs	Cf	Cs	Cf	Cs	Cf	Cs
7.5m		*11050 kg	8200 kg			*11050 kg	8700 kg						
6.0m		*10800 kg	6700 kg			*11400 kg	8550 kg	*13150 kg	12400 kg				
4.5m		9800 kg	5850 kg	10000 kg	6000 kg	*12300 kg	8200 kg	*15150 kg	11700 kg				
3.0m		9200 kg	5450 kg	9800 kg	5800 kg	13200 kg	7800 kg	*17200 kg	11000 kg				
1.5m		9050 kg	5300 kg	9600 kg	5650 kg	12850 kg	7500 kg	*18200 kg	10450 kg				
0m		9300 kg	5450 kg	9500 kg	5550 kg	12650 kg	7300 kg	18150 kg	10200 kg				
-1.5m		10150 kg	5900 kg	9500 kg	5550 kg	12550 kg	7250 kg	*17400 kg	10150 kg	*18450 kg	16100 kg		
-3.0m		*11200 kg	6950 kg			*12100 kg	7350 kg	*15600 kg	10300 kg	*19150 kg	16500 kg	*18450 kg	*18450 kg
-4.5m		*10500 kg	9300 kg					*12200 kg	10600 kg	*15150 kg	*15150 kg		

PC400LC-8R		Boom: 7060 mm		Arm: 2900 mm		Bucket: 1.90 m <sup>3</sup> ISO 7451 heaped		Shoe: 700 mm triple grouser					
B	A	☉ MAX		9.0 m		7.5 m		6.0 m		4.5 m		3.0 m	
		Cf	Cs	Cf	Cs	Cf	Cs	Cf	Cs	Cf	Cs	Cf	Cs
7.5m		*10050 kg	7400 kg			*10100 kg	8750 kg						
6.0m		*9900 kg	6100 kg	*9800 kg	6100 kg	*10650 kg	8550 kg						
4.5m		9100 kg	5350 kg	9950 kg	5900 kg	*11600 kg	8150 kg	*14150 kg	11750 kg	*18550 kg	*18550 kg		
3.0m		8500 kg	4950 kg	9700 kg	5700 kg	*12700 kg	7700 kg	*16300 kg	11000 kg				
1.5m		8350 kg	4800 kg	9500 kg	5500 kg	12750 kg	7350 kg	*17650 kg	10350 kg				
0m		8550 kg	4900 kg	9300 kg	5350 kg	12450 kg	7100 kg	*17900 kg	10000 kg				
-1.5m		9250 kg	5300 kg	9250 kg	5300 kg	12300 kg	7000 kg	*17450 kg	9850 kg	*22650 kg	15750 kg		
-3.0m		10700 kg	6150 kg			12350 kg	7050 kg	*16050 kg	9950 kg	*20,350 kg	16000 kg	*22050 kg	*22050 kg
-4.5m		*10550 kg	7950 kg			*9350 kg	7300 kg	*13300 kg	10250 kg	*16700 kg	16150 kg	*19650 kg	*19650 kg

PC400LC-8R		Boom: 7060 mm		Arm: 3380 mm		Bucket: 1.90 m <sup>3</sup> ISO 7451 heaped		Shoe: 700 mm triple grouser					
B	A	☉ MAX		9.0 m		7.5 m		6.0 m		4.5 m		3.0 m	
		Cf	Cs	Cf	Cs	Cf	Cs	Cf	Cs	Cf	Cs	Cf	Cs
7.5m		*6800 kg	6450 kg										
6.0m		*6800 kg	5450 kg	*9400 kg	6300 kg	*10150 kg	8750 kg						
4.5m		*7000 kg	4850 kg	*9900 kg	6100 kg	*11200 kg	8350 kg	*13450 kg	12050 kg				
3.0m		*7400 kg	4550 kg	9900 kg	5850 kg	*12400 kg	7950 kg	*15750 kg	11300 kg	*21600 kg	17650 kg		
1.5m		7650 kg	4400 kg	9650 kg	5650 kg	12950 kg	7550 kg	*17450 kg	10650 kg	*16950 kg	16350 kg		
0m		7800 kg	4500 kg	9450 kg	5450 kg	12600 kg	7300 kg	*18050 kg	10200 kg	*17000 kg	15850 kg		
-1.5m		8350 kg	4800 kg	9350 kg	5400 kg	12450 kg	7150 kg	*17900 kg	10000 kg	*22700 kg	15850 kg		
-3.0m		9450 kg	5450 kg	9350 kg	5400 kg	12450 kg	7100 kg	*16800 kg	10050 kg	*21800 kg	16000 kg	*18600 kg	*18600 kg
-4.5m		*9850 kg	6750 kg			*11050 kg	7300 kg	*14500 kg	10250 kg	*18550 kg	16350 kg	*23300 kg	*23,300 kg
-6.0m		*8800 kg	*8800 kg					*10150 kg	*10150 kg	*13350 kg	*13350 kg		

PC400LC-8R		Boom: 7060 mm		Arm: 4000 mm		Bucket: 1.60 m <sup>3</sup> ISO 7451 heaped		Shoe: 700 mm triple grouser							
B	A	☉ MAX		10.5 m		9.0 m		7.5 m		6.0 m		4.5 m		3.0 m	
		Cf	Cs	Cf	Cs	Cf	Cs	Cf	Cs	Cf	Cs	Cf	Cs	Cf	Cs
7.5m		*5850 kg	5800 kg			*8550 kg	6550 kg								
6.0m		*5800 kg	4950 kg			*8800 kg	6450 kg								
4.5m		*6000 kg	4450 kg	7800 kg	4650 kg	*9350 kg	6250 kg	*10500 kg	8550 kg						
3.0m		*6300 kg	4150 kg	7700 kg	4500 kg	10000 kg	5950 kg	*11800 kg	8100 kg	*14700 kg	11550 kg	*20750 kg	18,200 kg		
1.5m		*6850 kg	4050 kg	7500 kg	4350 kg	9700 kg	5700 kg	*12950 kg	7650 kg	*16750 kg	10800 kg	*23,300 kg	16650 kg		
0m		7200 kg	4100 kg	7400 kg	4250 kg	9450 kg	5500 kg	12650 kg	7300 kg	*17800 kg	10250 kg	*20450 kg	15850 kg		
-1.5m		7600 kg	4350 kg	7350 kg	4200 kg	9300 kg	5350 kg	12400 kg	7100 kg	17850 kg	9950 kg	*23250 kg	15600 kg	*11150 kg	*11150 kg
-3.0m		8450 kg	4850 kg			9300 kg	5300 kg	12300 kg	7000 kg	*17250 kg	9850 kg	*22850 kg	15650 kg	*19200 kg	*19200 kg
-4.5m		*9550 kg	5800 kg					*12050 kg	7100 kg	*15550 kg	10000 kg	*20,200 kg	15950 kg	*24850 kg	*24850 kg
-6.0m		*9150 kg	7950 kg					*8250 kg	7400 kg	*12250 kg	10350 kg	*15850 kg	*15850 kg	*20300 kg	*20300 kg

\* Load is limited by hydraulic capacity rather than tipping. Ratings are based on SAE J1097. Rated loads do not exceed 87% of hydraulic lift capacity or 75% of tipping load.



**LIFTING CAPACITY WITH LIFTING MODE**

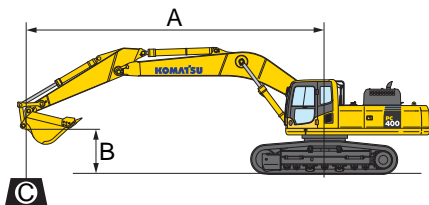

**PC400-8R SE Spec.**

- A: Reach from swing center
- B: Bucket hook height
- C: Lifting capacity
- Cf: Rating over front
- Cs: Rating over side
- ⊗: Rating at maximum reach

PC400-8R		Boom: 6670 mm		Arm: 2400 mm		Me Bucket: 2.80 m <sup>3</sup> ISO 7451 heaped		Shoe: 600 mm triple grouser					
B	A	⊗ MAX		9.0 m		7.5 m		6.0 m		4.5 m		3.0 m	
		Cf	Cs	Cf	Cs	Cf	Cs	Cf	Cs	Cf	Cs	Cf	Cs
7.5m		*10850 kg	8200 kg										
6.0m		9950 kg	6400 kg			*11050 kg	7800 kg	*12700 kg	11750 kg				
4.5m		8650 kg	5450 kg			11550 kg	7450 kg	*14400 kg	11050 kg	*19050 kg	17900 kg		
3.0m		8000 kg	5000 kg	8050 kg	5050 kg	11050 kg	7000 kg	16000 kg	10250 kg				
1.5m		7800 kg	4800 kg	7850 kg	4850 kg	10750 kg	6700 kg	15500 kg	9550 kg				
0m		8050 kg	4950 kg	7750 kg	4750 kg	10500 kg	6450 kg	15100 kg	9200 kg	*22450 kg	14150 kg		
-1.5m		8900 kg	5450 kg			10400 kg	6400 kg	15000 kg	9150 kg	*20500 kg	14800 kg	*20000 kg	*20000 kg
-6.0m													

\* Load is limited by hydraulic capacity rather than tipping. Ratings are based on SAE J1097. Rated loads do not exceed 87% of hydraulic lift capacity or 75% of tipping load.

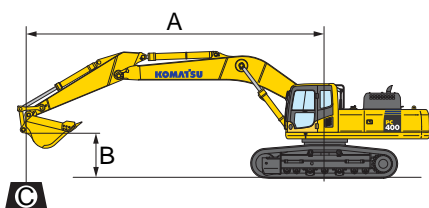

**PC400LC-8R SE Spec.**

- A: Reach from swing center
- B: Bucket hook height
- C: Lifting capacity
- Cf: Rating over front
- Cs: Rating over side
- ⊗: Rating at maximum reach

PC400LC-8R		Boom: 6670 mm		Arm: 2400 mm		Me Bucket: 2.80 m <sup>3</sup> ISO 7451 heaped		Shoe: 700 mm triple grouser					
B	A	⊗ MAX		9.0 m		7.5 m		6.0 m		4.5 m		3.0 m	
		Cf	Cs	Cf	Cs	Cf	Cs	Cf	Cs	Cf	Cs	Cf	Cs
7.5m		*10850 kg	8500 kg										
6.0m		*10600 kg	6650 kg			*11050 kg	8100 kg	*12700 kg	12150 kg				
4.5m		10050 kg	5700 kg			*11750 kg	7700 kg	*14400 kg	11400 kg	*19050 kg	18450 kg		
3.0m		9350 kg	5200 kg	9450 kg	5250 kg	*12550 kg	7250 kg	*16150 kg	10600 kg				
1.5m		9150 kg	5050 kg	9250 kg	5050 kg	12550 kg	7000 kg	*17050 kg	9950 kg				
0m		9450 kg	5200 kg	9100 kg	5000 kg	12300 kg	6750 kg	*17000 kg	9600 kg	*22450 kg	14700 kg		
-1.5m		10450 kg	5700 kg			*12250 kg	6700 kg	*16050 kg	9500 kg	*20500 kg	15350 kg	*20000 kg	*20000 kg
-6.0m													

\* Load is limited by hydraulic capacity rather than tipping. Ratings are based on SAE J1097. Rated loads do not exceed 87% of hydraulic lift capacity or 75% of tipping load.



## STANDARD EQUIPMENT

### ENGINE:

- Automatic engine warm-up system
- Corrosion resistor
- Dry type air cleaner, double element
- Electric priming pump
- Engine, Komatsu SAA6D125E-5
- Engine overheat prevention system
- Fuel pre-filter (With water separator)
- Radiator and oil cooler dust proof net
- Water separator

### ELECTRICAL SYSTEM:

- Alternator, 24 V/50 A
- Auto-decelerator
- Batteries, 2 X 12 V/110 Ah
- Working light, 2 (Boom and RH)

### HYDRAULIC SYSTEM:

- Boom holding valve
- Power maximizing system
- Pressure Proportional Control (PPC) hydraulic control system
- Two-mode setting for boom
- Working mode selection system

### GUARDS AND COVERS:

- Fan guard structure
- Track guiding guard, center section

### UNDERCARRIAGE:

- Hydraulic track adjusters (Each side)
- Track roller
  - PC400-8R, 7 each side
  - PC400LC-8R, 8 each side

- Track shoe
  - PC400-8R, 600 mm triple grouser
  - PC400LC-8R, 700 mm triple grouser

### OPERATOR ENVIRONMENT:

- Large multi-lingual LCD monitor
- Rear view mirrors (RH and LH)
- ROPS cab (ISO 12117-2)
- Seat belt, retractable

### OTHER EQUIPMENT:

- Counterweight, 9220 kg
- Electric horn
- Rear reflector
- Slip-resistant plates
- Travel alarm



## OPTIONAL EQUIPMENT

### ELECTRICAL SYSTEM:

- Alternator, 24 V/60 A
- Batteries, 2 X 12 V/140 Ah
- Working lights (2 on cab)

### HYDRAULIC SYSTEM:

- Attachment piping
- Long lubricating intervals for work equipment bushings
- Service valve

### UNDERCARRIAGE:

- Shoes, triple grouser shoes
  - PC400-8R 700 mm, 800 mm
  - PC400LC-8R 600 mm, 800 mm
- Track frame undercover
- Track roller guards (Full length)
- Variable track gauge

### OPERATOR ENVIRONMENT:

- A/C with defroster
- Bolt-on top guard, OPG top guard level 2 (ISO 10262)
- Cab accessories
  - Rain visor
  - Sun visor
- Cab front guard
  - Full height guard, OPG level 1 (ISO 10262)
  - Full height guard, OPG level 2 (ISO 10262)
  - Half height guard
- Heater with defroster
- Rear view mirror (Rear and sidewise)
- Rear view monitor system
- Seat, suspension
- Seat, suspension with heater

### WORK EQUIPMENT:

- Arms
  - 2400 mm arm assembly
  - 2400 mm SE arm assembly
  - 2900 mm arm assembly
  - 3380 mm arm assembly
  - 4000 mm arm assembly
- Booms
  - 7060 mm
  - 6670 mm SE boom assembly

### OTHER EQUIPMENT:

- Electric grease gun
- Fuel refill pump
- Pre-cleaner

**KOMATSU**<sup>®</sup>