

# KOMATSU®

## PC850-8R1

**PC**  
**850**

#### HORSEPOWER

Gross: 370 kW 496 HP / 1800 min<sup>-1</sup>

Net: 363 kW 487 HP / 1800 min<sup>-1</sup>

#### OPERATING WEIGHT

78600 – 79800 kg

#### BUCKET CAPACITY

3.40 – 4.30 m<sup>3</sup>



Photos may include optional equipment.

# **WALK-AROUND**



Photos may include optional equipment.

**PRODUCTIVITY, ECOLOGY & ECONOMY**

- High Power Komatsu SAA6D140E-5 Engine
- Economy Mode Four-level Setting
- Low Ambient Noise
- Working Mode Selection
- Heavy Lift Mode
- Swing Priority Mode
- Large Digging Force
- High Work Equipment Speed
- Large Drawbar Pull and Steering Force
- Two-mode Setting for Boom
- Shockless Boom Control

**RELIABILITY & DURABILITY**

- Boom Foot Hoses
- O-ring Face Seals
- Removed Water and Contamination in Fuel
- High-pressure In-line Filtration
- Highly Reliable Electronic Devices
- KMAX Bucket Teeth

**COMFORT & SAFETY**

- Large Comfortable Cab
- OPG Top Guard Level 2 (ISO 10262)
- Rear View Monitor System (Optional)

\* Information and Communication Technology

**ICT\* & KOMTRAX**

- Large Liquid Crystal Display (LCD) Monitor
- Equipment Management Monitoring System
- KOMTRAX

**MAINTENANCE**

- Easy Checking and Maintenance of Engine
- Easy Cleaning of Cooling Unit
- Large Handrail, Step and Catwalk



**PC850-8R1**

<b>HORSEPOWER</b>	Gross:	370 kW 496 HP / 1800 min <sup>-1</sup>
	Net:	363 kW 487 HP / 1800 min <sup>-1</sup>
<b>OPERATING WEIGHT</b>		78600 – 79800 kg
<b>BUCKET CAPACITY</b>		3.40 – 4.30 m <sup>3</sup>

# PRODUCTIVITY, ECOLOGY & ECONOMY

## Komatsu Technology

Komatsu develops and produces all major components, such as engines, electronics and hydraulic components, in house. With this “Komatsu Technology,” and adding customer feedback, Komatsu is achieving great advancements in technology. To achieve both high levels of productivity and economical performance, Komatsu has developed the main components with a total control system. The result is a new generation of high performance and environment friendly excavators.

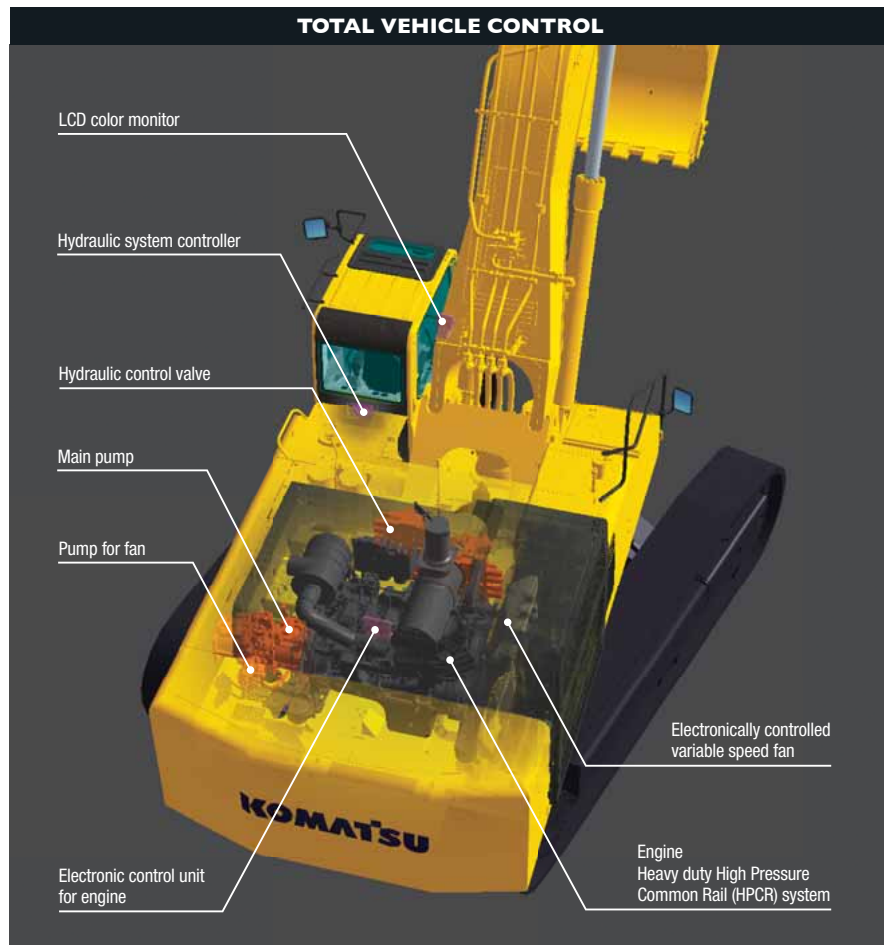
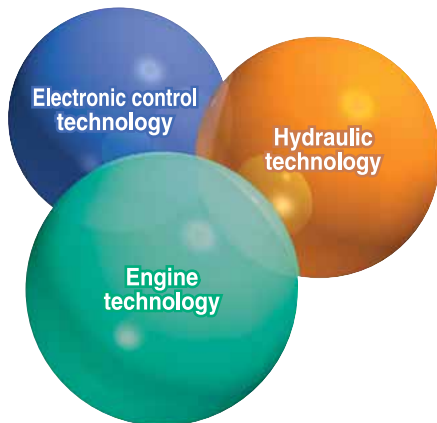

## High Power Komatsu SAA6D140E-5 Engine

Powerful turbocharged and air-to-air aftercooled Komatsu SAA6D140E-5 engine provides 363 kW 487 HP. This Komatsu SAA6D140E-5 engine is U.S. EPA Tier 2 and EU Stage 2 emissions equivalent. This Komatsu SAA6D140E-5 engine actualizes high-power to low fuel consumption with the optimum fuel injection by electronic heavy duty High Pressure Common Rail (HPCR) fuel injection system.



## Electronically Controlled Variable Speed Fan Contributes to Low Fuel Consumption and Low Noise

The electronic control system sets the revolution speed of the cooling fan according to the coolant, hydraulic oil, and ambient temperature; effectively uses the engine output to prevent wasteful fuel consumption; and reduces noise during low-speed fan revolution.

## Lower and Economical Fuel Consumption Using Economy Mode

Enables operator to set the Economy mode to four levels according to working conditions so that production requirement is achieved at the lowest fuel consumption.



## Low Ambient Noise

Reduced noise by adoption of an electronically controlled variable speed fan drive, large hybrid fan and low-noise muffler.

## ECO Gauge that Assists Energy-saving Operations

ECO gauge is equipped for environment friendly energy-saving operations. Operation in the green range allows reduction of CO<sub>2</sub> emission and fuel consumption.



ECO gauge

### Idling Caution

To prevent unnecessary fuel consumption, an idling caution is displayed on the monitor if the engine idles for 5 minutes or more.



### Auto Deceleration and Auto Idling System

Auto deceleration system is equipped to reduce fuel consumption and operating noise. Also, engine idling speed can be reduced on the monitor with the auto idling system.

### Working Modes Selectable

P and E modes established work modes are further improved.

**P mode** – Power or work priority mode has low fuel consumption, but fast equipment speed and maximum production and power are maintained.

**E mode** – Economy or fuel saving mode further reduces fuel consumption, but maintains the P-mode-like working equipment speed for light duty work.

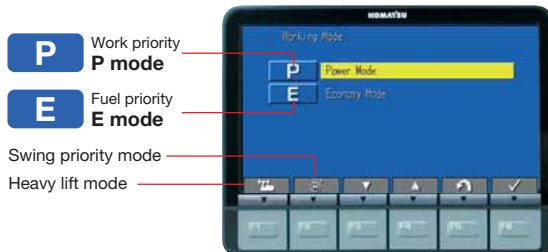

You can select Power or Economy modes using a one-touch button on the monitor panel depending on the workload.

### Heavy Lift Mode

Gives 10% more lifting force when needed for handling rock or heavy lifting applications.

### Swing Priority Mode

The swing priority mode allows the operator to use the same easy motion for 180° loading as 90° loading operations. By altering the oil flow, this setting allows you to select either boom or swing as the priority for increased production.

Selection	Result
ON	Oil flow to the swing motor is increased. 180° loading operations are most efficient.
OFF	Oil flow to the boom is increased. 90° loading operations are most efficient.

### Large Digging Force

With the one-touch Power Max. function digging force is further increased. (Approx. 8.5 seconds of operation)

**Maximum arm crowd force** (ISO 6015):  
298 kN (30.4 t) ➔ **327 kN (33.3 t)** **9.4% UP**  
(With Power Max.)

**Maximum bucket digging force** (ISO 6015):  
363 kN (37.0 t) ➔ **397 kN (40.5 t)** **9.4% UP**  
(With Power Max.)

Measured with Power Max. function, 3600 mm arm and ISO 6015 rating.

### Work Equipment Speed

An arm quick return circuit is provided for arm dumping. This returns a portion of oil flow directly to the hydraulic tank at arm dumping to reduce the hydraulic pressure loss. Speedier loading work can be accomplished by work equipment with quicker movement.



### Large Drawbar Pull and Steering Force

Since the machine has a large drawbar pull and a high steering force, it demonstrates excellent mobility even when it is on inclined sites.

### Two-mode Setting for Boom

Smooth mode provides easy operation for gathering blasted rock and scraping operations. When maximum digging force is needed, switch to power mode for more effective excavating.

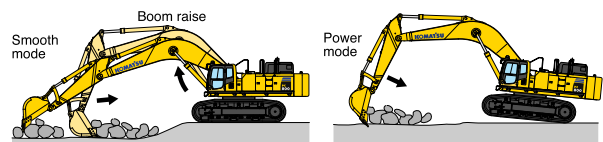

### Shockless Boom Control

The PC850-8R1 boom circuit features a shockless valve (Double-check slow return valve) to automatically reduces the amount of vibration present when operating the boom. Operator fatigue is reduced (Which can improve safety and productivity), and spillage caused by vibration is minimized.

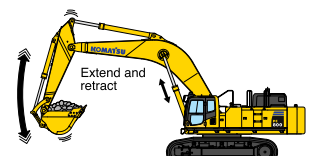

# RELIABILITY & DURABILITY

## Boom Foot Hoses

The boom foot hoses are arranged under the boom foot to reduce hose bend during operation, extending hose life and improving operator safety.



## Frame Structure

The revolving frame mount and center frame mount on the swing circle are no welding structure so that force is transmitted directly to the thick plate of the frame without passing through any welding.

## O-ring Face Seal

The hydraulic hose seal method has been changed from a conventional taper seal to an O-ring seal. This provides improved sealing performance during operation.

## Fuel Pre-filter (With Water Separator)

Removes water and contaminants from fuel to enhance the fuel system reliability.



## High Efficiency Fuel Filter

Fuel system reliability is even better with high efficiency fuel filter.



## High-pressure In-line Filtration

The PC850-8R1 has the most extensive filtration system available, providing in-line filters as standard equipment. An in-line filter in the outlet port of each main hydraulic pump reduces failures caused by contamination.

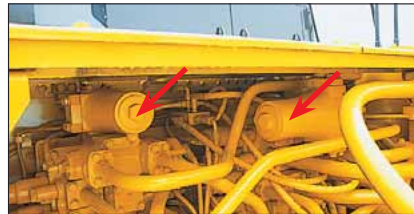

## Metal Guard Rings

Metal guard rings protect all the hydraulic cylinders and improve reliability.

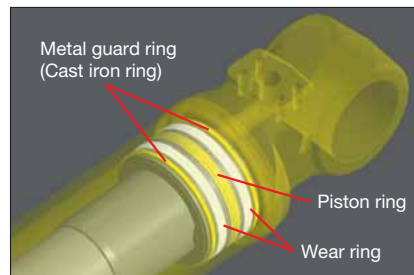

## Heat-resistant Wiring

Heat-resistant wiring is utilized for the engine electric circuit and other major component circuit.

## Water Separator

Removes water from the fuel and improves the reliability of fuel systems.



## Sturdy Undercarriage

The undercarriage is strengthened to provide excellent reliability and durability when working on rocky ground or blasted rock.



**Sturdy guards** shield the travel motors and piping against damage from rocks.



**Full length track roller guard**

## Sealed Connectors

Sealed connectors seal tight and have higher reliability.

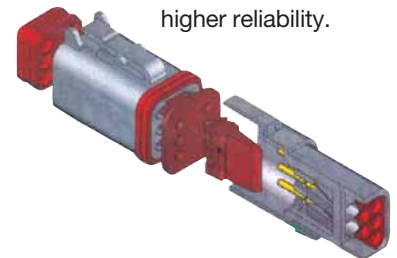

## Circuit Breaker

With circuit breaker, the machine can be easily restarted after repair.



## Strengthened Quarry Bucket Provides Outstanding Wear-resistance

The PC850-8R1 has the bucket for specific use in quarry, this is strong in impact and wear, and providing high performance and long life. Komatsu KVV's hard materials\* provide excellent wear resistance. Combined with adoption of long-life KMAX teeth, durability of bucket is drastically enhanced.

\* Komatsu KVV's hard materials: Komatsu KVV developed, wear-resistant, reinforced materials. Brinell hardness: 500 or more (180 kg/mm<sup>2</sup> class). Features high wear-resistance and little quality change from the heat generated during rock loading, maintaining long term hardness.

### KMAX Tooth

- Unique bucket tooth shape for superior digging performance
- Long-term high sharpness
- Great penetration performance
- Hammerless, safe, and easy tooth replacement (Tooth replacement time: Half of the conventional machine.)

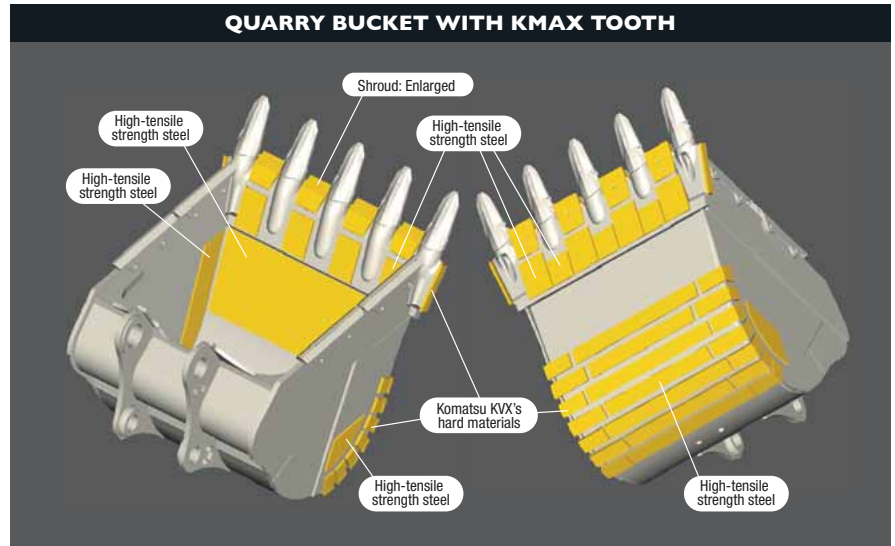

#### STEP 1

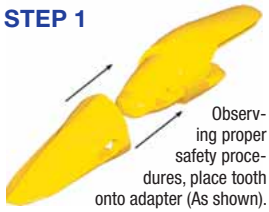

#### STEP 2

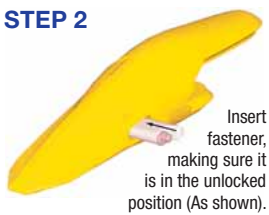

#### STEP 3



Using the correct size socket, rotate the pin locking shaft 90° clockwise (As shown) to finish the installation.

#### STEP 4



To remove fastener, use the correct size socket to rotate the pin locking shaft 90° counter-clockwise (As shown). Remove fastener and tooth. Repeat steps 1-3 for a new installation.

Photo may include optional equipment.



# COMFORT



## Wide Newly-designed Cab

Newly-designed wide spacious cab includes seat with reclining backrest. The seat height and longitudinal inclination are easily adjusted using a pull-up lever. You can set the appropriate operational position of the armrest and the console. The reclining seat further enables you to place it into the fully flat state with the headrest attached.



Seat with headrest reclined full flat

## Low Noise Design Cab

The newly-designed cab is highly rigid and has excellent sound absorption. Improvements in noise source reduction combined with the use of a low noise engine, hydraulic equipment, and optional air conditioner allows the operator to work in quiet operating condition.

Operator ear's noise

**2 dB(A) reduced**

Compared with the current model

## Pressurized Cab

Optional air conditioner, air filter and a higher internal air pressure minimize external dust from entering the cab.

### Multi-position Controls

The multi-position, Pressure Proportional Control (PPC) levers allow the operator to work in comfort while maintaining precise control. A double-slide mechanism allows the seat and control levers to move together or independently, allowing the operator to position the controls for maximum productivity and comfort.



Seat sliding amount: 340 mm

### Low Vibration with Cab Damper Mounting

PC850-8R1 uses viscous damper mounts for the cab that incorporates longer stroke and the addition of a spring. The cab damper mounting combined with high rigidity deck aids vibration reduction at the operator's seat.

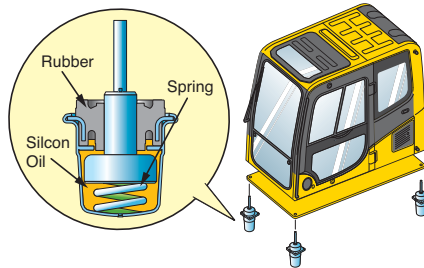

### Automatic Air Conditioner (A/C) (Optional)

Enables you to easily and precisely set cab atmosphere with the instruments on the large LCD. The automatic air conditioner uses a bi-level control function that keeps the operator's head and feet cool and warm respectively. This improved air flow function keeps the inside of the cab comfortable throughout the year.



Defroster function keeps the front glass clear.

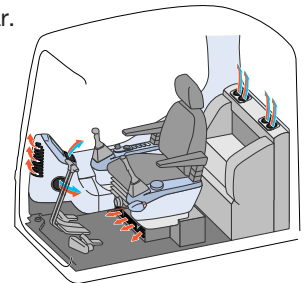

### Cab Equipments



Skylight



Sliding Window and Large Side Mirror



Defroster

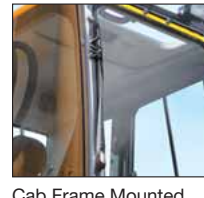

Cab Frame Mounted Wiper



Bottle Holder and Magazine Rack

## SAFETY

### Step Light with Timer

Provides light for about one minute to allow the operator to get off the machine safely.



### Horn Interconnected with Warning Light (Optional)

Gives visual and audible notice of the excavator's operation when activated.



### Rear View Monitor System (Optional)

The operator can view the rear of the machine with a color monitor screen.



### Pump/Engine Room Partition

Prevents oil from spraying on the engine if a hydraulic hose should burst.



### Thermal and Fan Guards

Are placed around high-temperature parts of the engine and fan drive.

### Slip-resistant Plates

Spiked plates on working areas provide slip-resistant performance.

LARGE LCD COLOR MONITOR



Large Multi-lingual LCD Monitor

A large user-friendly color monitor enables safe, accurate and smooth work. Improved screen visibility is achieved by the use of LCD that can easily be read at various angles and lighting conditions. The switches are simple and easy to operate. Function keys facilitate multi-function operations. Displays data in 12 languages to support operators around the world.

Indicators

- 1 Auto-decelerator
- 2 Working mode
- 3 Travel speed
- 4 Engine water temperature gauge
- 5 Hydraulic oil temperature gauge
- 6 Fuel gauge
- 7 ECO gauge
- 8 Function switches menu

Basic operation switches

- 1 Auto-decelerator (& auto idling)
- 2 Working mode selector
- 3 Traveling selector
- 4 Buzzer cancel
- 5 Wiper
- 6 Windshield washer

Mode Selection

The multi-function color monitor has Power mode and Economy mode (Four levels).

Working Mode	Application	Advantage
<b>P</b> (P0,P1)	Power mode	<ul style="list-style-type: none"> <li>Maximum production/power</li> <li>Fast cycle time</li> </ul>
<b>E</b> (E0,E1,E2,E3)	Economy mode	<ul style="list-style-type: none"> <li>Good cycle time</li> <li>Good fuel economy</li> </ul>

Additionally, it is possible to select “Heavy lift mode” or “Swing priority mode” for each Power mode and Economy mode.

Selection	Display on the monitor
Heavy Lift Mode	
Swing Priority Mode	

Equipment Management Monitoring System

Monitor function

Controller monitors engine oil level, coolant temperature, battery charge and air clogging, etc. If controller finds any abnormality, it is displayed on the LCD.



Maintenance function

Monitor informs replacement time for oil and filters when the replacement interval is reached.



Trouble data memory function

Monitor stores abnormalities for effective troubleshooting.

**KOMTRAX**

*The Komatsu remote monitoring and management technology provides insightful data about your equipment and fleet in user-friendly format.*

**Energy Saving Operation Report**

KOMTRAX delivers the energy-saving operation report based on the operating information such as fuel consumption, load summary and idling time, which helps you efficiently run a business.

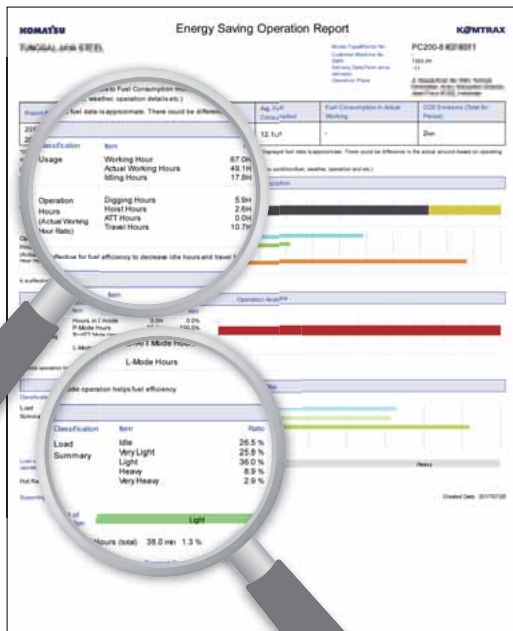

This report image is an example of hydraulic excavator

**Equipment Management Support**

Through the web application, a variety of search parameters are available to quickly find information about specific machines based on key factors. Moreover, KOMTRAX finds out machines with problems from your fleet and shows you through an optimal interface.

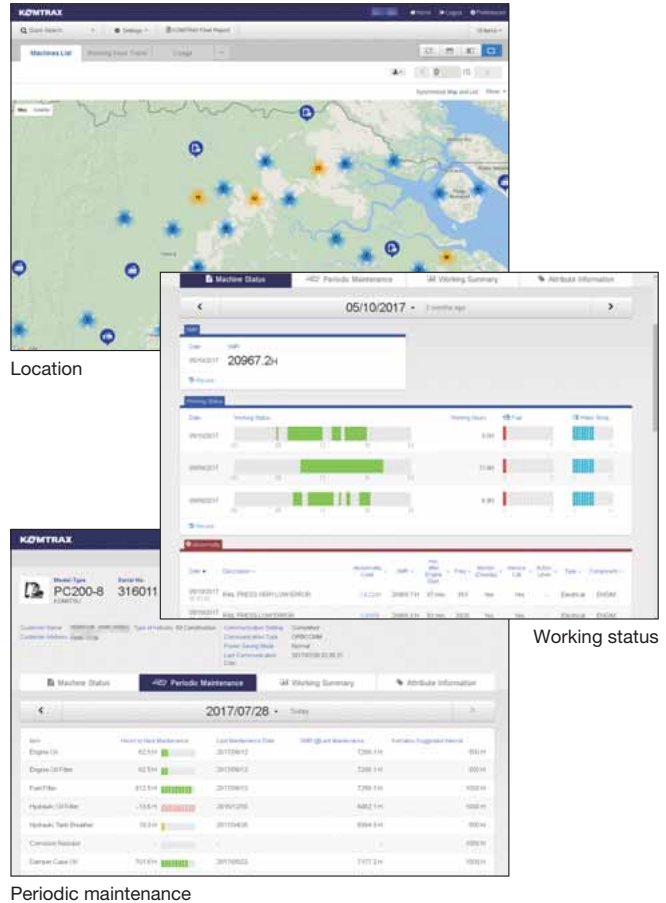

Location

Working status

Periodic maintenance

The report contents and data depend on the machine model.

**Optimal Strategy for Efficient Work**

The detailed information that KOMTRAX puts at your fingertips helps you manage your fleet conveniently on the web anytime, anywhere. It gives you the power to make better daily and long-term strategic decisions.



# MAINTENANCE

## Easy Checking and Maintenance of Engine

Engine check points are concentrated on one side of the engine to facilitate daily checks. Thermal guards are placed around high-temperature parts such as turbocharger.



## One-touch Drain Cock

Easier, cleaner engine oil changes.

## Easy Cleaning of Cooling Unit

Reverse-rotation function of the hydraulic driven fan simplifies cleaning out the cooling unit. In addition, this function contributes to reducing warming-up run time in low temperature and discharging hot air from the engine room to keep appropriate heat balance.

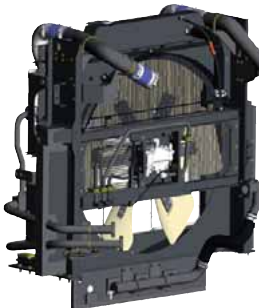

## Long-life Oil, Filter

Uses high-performance filtering materials and long-life oil. Extends the oil and filter replacement interval.



Hydraulic oil filter

<b>Engine oil &amp; Engine oil filter</b>	every <b>500</b> hours
<b>Hydraulic oil</b>	every <b>5000</b> hours
<b>Hydraulic oil filter</b>	every <b>1000</b> hours

## Wide Catwalk

Easier, safer operator cab access and maintenance checks.



## Steps Connected to the Machine Cab

Steps allows access from left hand catwalk to top of machine for engine check and maintenance.



## Convenient Utility Space to the Machine Cab

Utility space provides great convenience to store tools, spare parts, etc.



## Divided Type Engine Cover

The divided engine cover allows easily access to inspection points around the engine.

## Washable Cab Floormat

Cab floormat is easy to keep clean. The gently inclined surface has a flanged floormat and drainage holes to facilitate runoff.



## Electric Pump, Grease Gun with Indicator (Optional)

Greasing is made easy with the electric pump and grease gun with indicator.

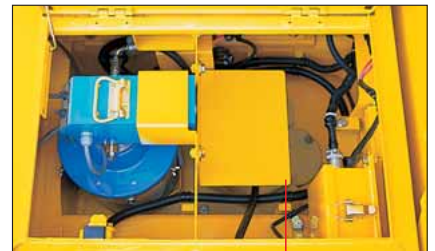

Grease can drum storage location



Grease gun  
The grease gun can be reached from ground level.  
Indicator



Photo may include optional equipment.

# KOMATSU BRAND BUCKET

## KOMATSU Brand Bucket

### Me Bucket Feature

- Low resistant excavation
- High productivity
- High durability
- High fuel efficiency



Conventional



Me bucket

### Category and Feature

Category	Load / Wear / Soil (Application)	Image
<b>Heavy Duty HD</b>	<b>Load</b> Machine power is high during majority of the work. Medium, but continuous shock load <b>Wear</b> Material is abrasive. Light scratch marks can be seen at the bucket. <b>Soil</b> Limestone, shot rock, compact mix of sand, gravel and clay	
<b>General Purpose GP</b>	<b>Load</b> Machine power is mostly medium, but occasionally high. Bucket movements are smooth with minor shock load. Bucket penetrates easily. <b>Wear</b> Material is lightly abrasive. Some sand may be medium abrasive. <b>Soil</b> Mostly loose sand, gravel and finely broken materials	

### Bucket Line-up

Bucket Type	Capacity (m <sup>3</sup> ) (ISO 7451)	Width*1 (mm)	Weight*2 (kg)	Tooth Quantity	Boom + Arm (m)			Tooth Type	Photo No.
					STD	SE			
					8.04+3.6	7.1+2.9	7.1+3.6	KMAX	
Conventional	3.40	1870<1820>[2070]	3990	5	○	—	—	✓	①
	4.00	2050<2000>[2250]	4230	5	—	○	—	✓	②
	4.00	2050<2000>[2250]	4260	5	—	—	○	✓	③
	4.00	2100<2000>[ — ]	3730	5	—	○	—	✓	④
	4.30	2250<2150>[ — ]	3940	6	—	○	—	✓	⑤
	4.50	2330<2230>[ — ]	4030	6	—	—	—	✓	⑥
Me Bucket	4.50*3	2050<2000>[2250]	4585	5	—	□	—	✓	⑦
Special Order	5.00*3	Special order			—	□	—	Special order	
	5.50*3*4				—	□	—		
	6.00*3*4				—	□	—		

\*1 With side shrouds, < > without side shrouds, [ ] bucket lip width \*2 With side shrouds \*3 Special Features Request required for Komatsu authorization by application.

\*4 For LC undercarriage model only ○: General purpose use, density up to 1.8 t/m<sup>3</sup> □: General purpose use, density up to 1.5 t/m<sup>3</sup> ✓: Selectable

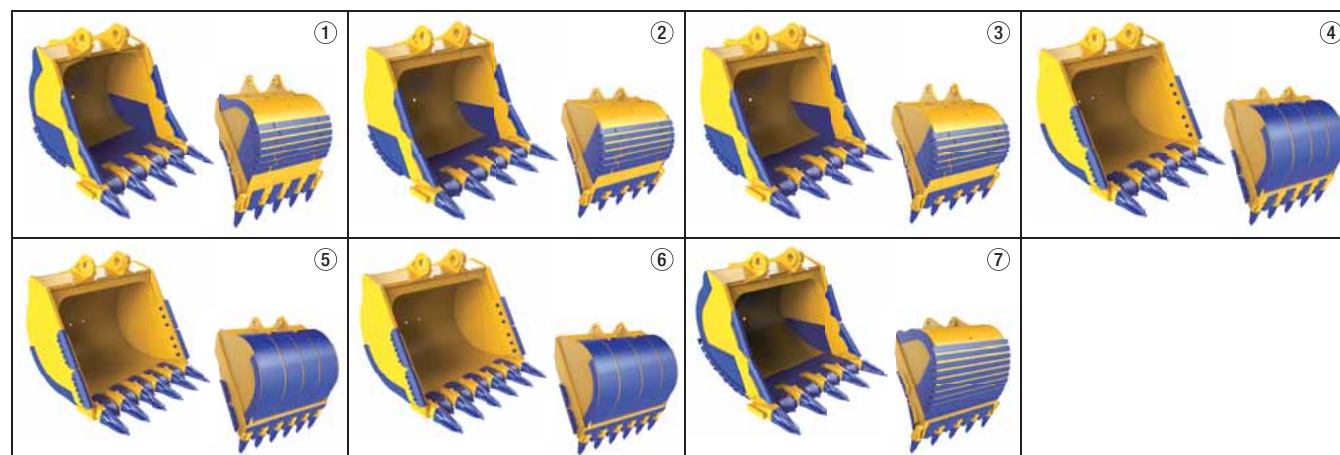

# SE SPEC.

PC850-8R1 SE spec. is equipped with a large bucket. It increases the efficiency of loading a dump truck with large amounts of loose materials such as blasted rock.



Photos may include optional equipment.

# OPTIONS

- Cab front full height guard level 2 (ISO 10262)



- Lower wiper



- Flashing light



- Strengthened track frame undercover



- Rain visor



# KOMATSU TOTAL SUPPORT



## Komatsu Total Support

To keep your machine available and minimize operation cost when you need it, Komatsu Distributor is ready to provide a variety of supports before and after procuring the machine.

### Fleet recommendation

Komatsu Distributor can study the customer's job site and provide the most optimum fleet recommendation with detailed information to meet all of your application needs when you are considering to buy new machines or replace the existing ones from Komatsu.



### Product support

Komatsu Distributor gives the proactive support and secures the quality of the machinery that will be delivered.

### Parts availability

Komatsu Distributor is available for emergency inquiry by the customers for genuine, quality guaranteed Komatsu parts.

### Technical support

Komatsu product support service (Technical support) is designed to help customer. Komatsu Distributor offers a variety of effective services to show how much Komatsu is dedicated to the maintenance and support of Komatsu machine.

- Preventive Maintenance (PM) clinic
- Oil & Wear analysis program
- Undercarriage inspection service, etc.



### Repair & maintenance service

Komatsu Distributor offers quality repair and maintenance service to the customer, utilizing and promoting Komatsu developed programs.

### Komatsu Reman (Remanufactured) components

Komatsu Reman products are the result of the implementation of the Komatsu global policy which establishes and agrees to reduce the owning, operating and total Life Cycle Costs (LCC) to Komatsu's customer through high quality, prompt delivery and competitively priced in own remanufactured products (QDC).



# SPECIFICATIONS



## ENGINE

Model ..... Komatsu SAA6D140E-5  
 Type ..... 4-cycle, water-cooled, direct injection  
 Aspiration ..... Turbocharged, aftercooled  
 Number of cylinders ..... 6  
 Bore ..... 140 mm  
 Stroke ..... 165 mm  
 Piston displacement ..... 15.24 L  
 Governor ..... All-speed, electronic  
 Horsepower:  
   SAE J 1995 ..... Gross 370 kW 496 HP  
   ISO 9249 / SAE J1349\* ..... Net 363 kW 487 HP  
 Rated rpm ..... 1800 min<sup>-1</sup>  
 Fan drive type ..... Hydraulic

\* Net horsepower at the maximum speed of radiator cooling fan is 338 kW 454HP.  
 U.S. EPA Tier 2 and EU Stage 2 emissions equivalent.



## HYDRAULIC SYSTEM

Type ..... Open-center load-sensing system  
 Number of selectable working modes ..... 2  
 Main pump:  
   Type ..... Variable-capacity piston pumps  
   Pumps for ..... Boom, arm, bucket, swing, and travel circuits  
   Maximum flow ..... 2 x 494 L/min  
   Fan drive pump ..... Variable capacity piston type  
 Hydraulic motors:  
   Travel ..... 2 x axial piston motor with parking brake  
   Swing ..... 2 x axial piston motor with swing holding brake  
 Relief valve setting:  
   Implement circuits ..... 31.4 MPa 320 kgf/cm<sup>2</sup>  
   Travel circuit ..... 34.3 MPa 350 kgf/cm<sup>2</sup>  
   Swing circuit ..... 28.4 MPa 290 kgf/cm<sup>2</sup>  
   Heavy lift circuit ..... 34.3 MPa 350 kgf/cm<sup>2</sup>  
   Pilot circuit ..... 2.9 MPa 30 kgf/cm<sup>2</sup>  
 Hydraulic cylinders:  
 (Number of cylinders—bore x stroke x rod diameter)  
   Boom ..... 2 – 200 mm x 1950 mm x 140 mm  
   Arm (STD/SE) ..... 2 – 185 mm x 1610 mm x 120 mm  
   Bucket  
     STD ..... 1 – 185 mm x 1820 mm x 130 mm  
     SE ..... 1 – 225 mm x 1420 mm x 160 mm



## SWING SYSTEM

Driven method ..... Hydraulic motors  
 Swing reduction ..... Planetary gear  
 Swing circle lubrication ..... Grease-bathed  
 Swing lock ..... Oil disc brake  
 Swing speed ..... 6.8 min<sup>-1</sup>



## DRIVES AND BRAKES

Steering control ..... Two levers with pedals  
 Drive method ..... Fully hydrostatic  
 Travel motor ..... Axial piston motor, in-shoe design  
 Reduction system ..... Planetary gear triple reduction  
 Maximum drawbar pull ..... 559 kN 57000 kgf  
 Gradeability ..... 70%  
 Maximum travel speed  
   Low ..... 2.8 km/h  
   High ..... 4.2 km/h  
 Service brake ..... Hydraulic lock  
 Parking brake ..... Oil disc brake



## UNDERCARRIAGE

Center frame ..... H-leg frame  
 Track frame ..... Box-section  
 Seal of track ..... Sealed  
 Track adjuster ..... Hydraulic  
 No. of shoes (Each side) ..... 47  
 No. of carrier rollers (Each side) ..... 3  
 No. of track rollers (Each side) ..... 8



## COOLANT AND LUBRICANT CAPACITY (REFILLING)

Fuel tank ..... 980 L  
 Radiator ..... 100 L  
 Engine ..... 53 L  
 Final drive, each side ..... 20 L  
 Swing drive ..... 24.5 x 2 L  
 Hydraulic tank ..... 470 L



## OPERATING WEIGHT (APPROXIMATE)

PC850-8R1: Operating weight, including 8040 mm boom, 3600 mm arm, ISO 7451 heaped 3.40 m<sup>3</sup> backhoe bucket, operator, lubricant, coolant, full fuel tank, and the standard equipment  
 PC850-8R1 SE spec.: Operating weight, including 7100 mm boom, 2945 mm arm, ISO 7451 heaped 4.30 m<sup>3</sup> backhoe bucket, operator, lubricant, coolant, full fuel tank, and the standard equipment

Shoes	PC850-8R1		PC850-8R1 SE Spec.	
	Operating Weight	Ground Pressure	Operating Weight	Ground Pressure
610 mm	79000 kg	128 kPa 1.31 kgf/cm <sup>2</sup>	78600 kg	128 kPa 1.31 kgf/cm <sup>2</sup>
710 mm	79800 kg	112 kPa 1.14 kgf/cm <sup>2</sup>	79400 kg	111 kPa 1.13 kgf/cm <sup>2</sup>



**DIMENSIONS**

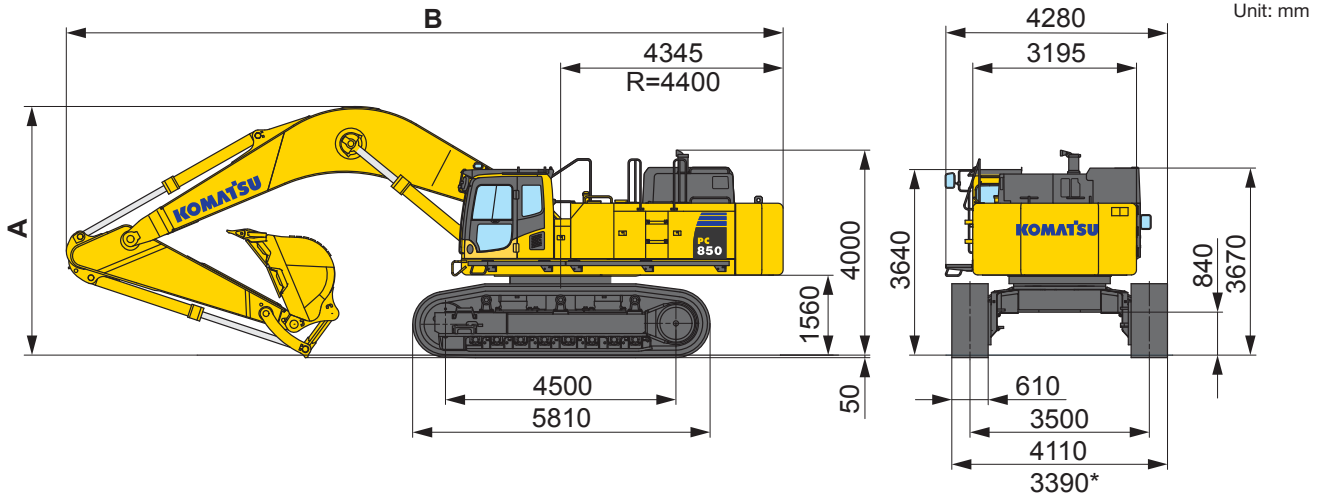

\* When retracted

Model	PC850-8R1	PC850-8R1 SE Spec.
Boom Length	8040 mm	7100 mm
Arm Length	3600 mm	2945 mm
A Overall height	4850 mm	4615 mm
B Overall length	13995 mm	13130 mm



**WORKING RANGE**

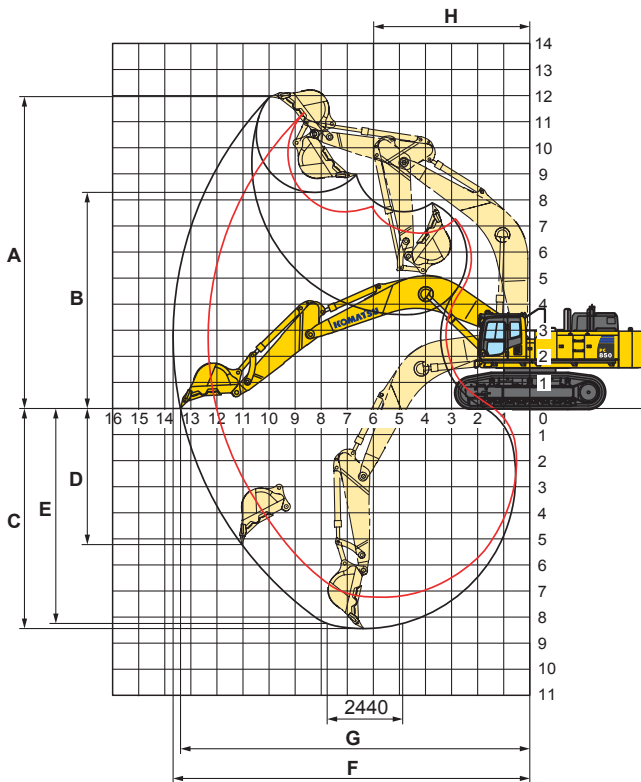

— : PC850-8R1 8040 mm boom, 3600 mm arm  
 — : PC850-8R1 SE spec. 7100 mm boom, 2945 mm arm

Model	PC850-8R1	PC850-8R1 SE Spec.		
Boom Length	8040 mm	7100 mm		
Arm Length	3600 mm	2945 mm	3600 mm	
A Max. digging height	11955 mm	11330 mm	11055 mm	
B Max. dumping height	8235 mm	7525 mm	7430 mm	
C Max. digging depth	8445 mm	7130 mm	7790 mm	
D Max. vertical wall digging depth	5230 mm	4080 mm	4260 mm	
E Max. digging depth of cut for 2440 mm level	8310 mm	6980 mm	7680 mm	
F Max. digging reach	13660 mm	12265 mm	12710 mm	
G Max. digging reach at ground level	13400 mm	11945 mm	12400 mm	
H Min. swing radius	5985 mm	5645 mm	5440 mm	
SAE J 1179 Rating	Bucket digging force at power max.	345 kN 35200 kgf	428 kN 43600 kgf	345 kN 35200 kgf
	Arm crowd force at power max.	312 kN 31800 kgf	363 kN 37000 kgf	312 kN 31800 kgf
ISO 6015 Rating	Bucket digging force at power max.	397 kN 40500 kgf	471 kN 48000 kgf	397 kN 40500 kgf
	Arm crowd force at power max.	327 kN 33300 kgf	374 kN 38100 kgf	327 kN 33300 kgf



## LIFTING CAPACITY

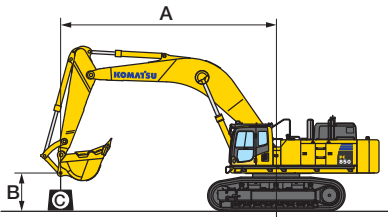

### PC850-8R1

- A: Reach from swing center
- B: Bucket hook height
- C: Lifting capacity
- Cf: Rating over front
- Cs: Rating over side
- ⊗: Rating at maximum reach

#### HEAVY LIFT "OFF"

PC850-8R1 Boom: 8040 mm Arm: 3600 mm Bucket: 3.40 m <sup>3</sup> ISO 7451 heaped Shoe: 610 mm double grouser Counterweight: 11.85 t													
B	A	⊗ MAX		9.0 m		7.5 m		6.0 m		4.5 m		3.0 m	
		Cf	Cs	Cf	Cs	Cf	Cs	Cf	Cs	Cf	Cs	Cf	Cs
6.0 m		*9300 kg	8650 kg	*11050 kg	*11050 kg	*12800 kg	*12800 kg						
3.0 m		9850 kg	7250 kg	*13250 kg	12300 kg	*16450 kg	*16450 kg	*22050 kg	*22050 kg				
0 m		9850 kg	7150 kg	*14800 kg	10950 kg	*18700 kg	14750 kg	*20950 kg	*20950 kg	*19850 kg	*19850 kg		
-3.0 m		*11800 kg	8600 kg	*14350 kg	10550 kg	*18150 kg	14250 kg	*21250 kg	20750 kg	*21150 kg	*21150 kg	*24450 kg	*24450 kg
-6.0 m		*12550 kg	*12550 kg			*12900 kg	*12900 kg	*17050 kg	*17050 kg	*21300 kg	*21300 kg		

#### HEAVY LIFT "ON"

PC850-8R1 Boom: 8040 mm Arm: 3600 mm Bucket: 3.40 m <sup>3</sup> ISO 7451 heaped Shoe: 610 mm double grouser Counterweight: 11.85 t													
B	A	⊗ MAX		9.0 m		7.5 m		6.0 m		4.5 m		3.0 m	
		Cf	Cs	Cf	Cs	Cf	Cs	Cf	Cs	Cf	Cs	Cf	Cs
6.0 m		*10550 kg	8650 kg	*12850 kg	*12850 kg	*14750 kg	*14750 kg						
3.0 m		9850 kg	7250 kg	*15400 kg	12300 kg	*18950 kg	*16800 kg	*23400 kg	*23400 kg				
0 m		9850 kg	7150 kg	14800 kg	10950 kg	19950 kg	14750 kg	*20950 kg	*20950 kg	*22100 kg	*22100 kg		
-3.0 m		11800 kg	8600 kg	14350 kg	10550 kg	19400 kg	14250 kg	*21250 kg	20750 kg	*21150 kg	*21150 kg	*24450 kg	*24450 kg
-6.0 m		*14850 kg	*14850 kg			*15250 kg	*15250 kg	*20000 kg	*20000 kg	*21300 kg	*21300 kg		

\* Load is limited by hydraulic capacity rather than tipping. Ratings are based on ISO 10567. Rated loads do not exceed 87% of hydraulic lift capacity or 75% of tipping load.

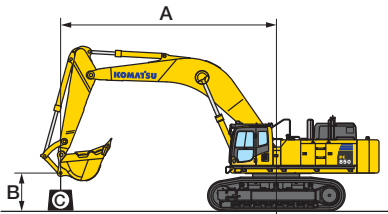

### PC850-8R1 SE Spec.

- A: Reach from swing center
- B: Bucket hook height
- C: Lifting capacity
- Cf: Rating over front
- Cs: Rating over side
- ⊗: Rating at maximum reach

#### HEAVY LIFT "OFF"

PC850-8R1 SE Spec. Boom: 7100 mm Arm: 2945 mm Bucket: 4.30 m <sup>3</sup> ISO 7451 heaped Shoe: 610 mm double grouser Counterweight: 11.85 t													
B	A	⊗ MAX		9.0 m		7.5 m		6.0 m		4.5 m		3.0 m	
		Cf	Cs	Cf	Cs	Cf	Cs	Cf	Cs	Cf	Cs	Cf	Cs
6.0 m		*12150 kg	11100 kg	*12650 kg	*12650 kg	*14250 kg	*14250 kg						
3.0 m		12400 kg	9250 kg	*14500 kg	12350 kg	*17700 kg	17100 kg	*23250 kg	*23250 kg				
0 m		12700 kg	9400 kg	15250 kg	11350 kg	*19700 kg	15450 kg	*26050 kg	22250 kg	*28450 kg	*28450 kg		
-3.0 m		*14400 kg	12350 kg			*17850 kg	15300 kg	*23350 kg	22200 kg	*30850 kg	*30850 kg	*31850 kg	*31850 kg

#### HEAVY LIFT "ON"

PC850-8R1 SE Spec. Boom: 7100 mm Arm: 2945 mm Bucket: 4.30 m <sup>3</sup> ISO 7451 heaped Shoe: 610 mm double grouser Counterweight: 11.85 t													
B	A	⊗ MAX		9.0 m		7.5 m		6.0 m		4.5 m		3.0 m	
		Cf	Cs	Cf	Cs	Cf	Cs	Cf	Cs	Cf	Cs	Cf	Cs
6.0 m		*14100 kg	11100 kg	*14650 kg	13600 kg	*16350 kg	*16350 kg						
3.0 m		12400 kg	9250 kg	16300 kg	12350 kg	*20350 kg	17100 kg	*26550 kg	24850 kg				
0 m		12700 kg	9400 kg	15250 kg	11350 kg	20650 kg	15450 kg	*29800 kg	22250 kg	*31350 kg	*31350 kg		
-3.0 m		16500 kg	12350 kg			20550 kg	15300 kg	*26850 kg	22200 kg	*32100 kg	*32100 kg	*31850 kg	*31850 kg

\* Load is limited by hydraulic capacity rather than tipping. Ratings are based on ISO 10567. Rated loads do not exceed 87% of hydraulic lift capacity or 75% of tipping load.



**TRANSPORTATION GUIDE**

Transportation specifications (Length x height x width)

Specs shown include the following equipment:

STD spec. : Boom 8040 mm, Arm 3600 mm, Bucket 3.40 m<sup>3</sup>, Shoes 610 mm double grouser

SE spec. : Boom 7100 mm, Arm 2945 mm, Arm 3600 mm, Bucket 4.30 m<sup>3</sup>, Shoes 610 mm double grouser

**3 Kits Transportation**

**Work equipment assembly**

Weight : STD spec. : 18.9 t  
SE spec. : 18.5 t

**Boom**



STD spec. : 8.1 t : 8370 x 2695 x 1500 mm  
SE spec. : 7.3 t : 7430 x 2480 x 1500 mm

**Arm**

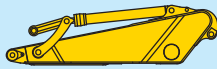

STD spec. : 4.5 t : 4765 x 1450 x 710 mm  
SE spec. : 4.9 t : 4075 x 1690 x 715 mm (2945 mm SE arm)  
4.5 t : 4765 x 1450 x 710 mm (3600 mm SE arm)

**Bucket**



STD spec. : 4.0 t : 2470 x 1880 x 2070 mm  
SE spec. : 3.9 t : 2280 x 1950 x 2250 mm

**Boom & Arm cylinder**



Total 2.5 t

**4 Kits Transportation**

**Work equipment assembly**

Weight : STD spec. : 18.9 t  
SE spec. : 18.5 t

**Boom**

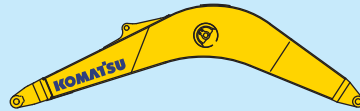

STD spec. : 8.1 t : 8370 x 2695 x 1500 mm  
SE spec. : 7.3 t : 7430 x 2480 x 1500 mm

**Arm**

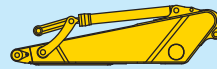

STD spec. : 4.5 t : 4765 x 1450 x 710 mm  
SE spec. : 4.9 t : 4075 x 1690 x 715 mm (2945 mm SE arm)  
4.5 t : 4765 x 1450 x 710 mm (3600 mm SE arm)

**Bucket**



STD spec. : 4.0 t : 2470 x 1880 x 2070 mm  
SE spec. : 3.9 t : 2280 x 1950 x 2250 mm

**Boom & Arm cylinder**



Total 2.5 t

**Base machine**

(Both PC850-8R1 and PC850-8R1 SE spec. are designed with the same weight and dimensions.)

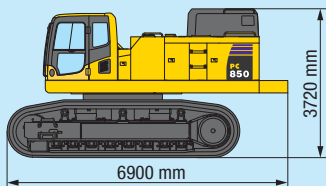

Width : 3390 mm  
Weight : 47.7 t

**Upper structure**

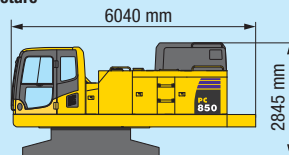

Width : 3225 mm  
Weight : 26.3 t

**Undercarriage**

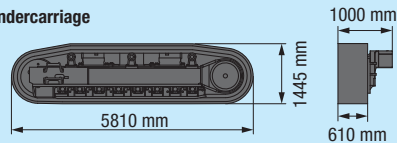

Weight : 21.4 t [10.7 t x 2]

**Others**

Weight : 12.4 t

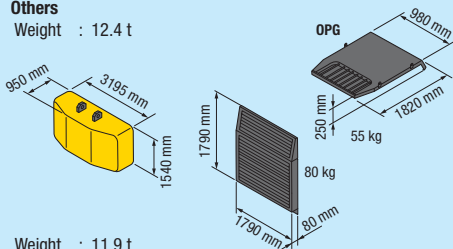

Weight : 11.9 t

**Others**

Weight : 12.4 t

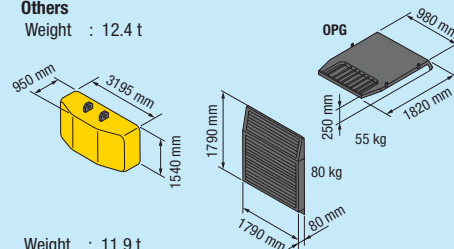

Weight : 11.9 t



## STANDARD EQUIPMENT

### ENGINE AND RELATED ITEMS:

- Air cleaner, double element, dry
- Engine, Komatsu SAA6D140E-5
- Variable speed cooling fan, with fan guard

### ELECTRICAL SYSTEM:

- Alternator, 24 V/60 A
- Auto decelerator and auto idling system
- Batteries, 2 x 12 V/170 Ah
- Starting motors, 11 kW
- Step light with timer
- Working lights  
2 on boom, 1 at right front, 2 on cab

### UNDERCARRIAGE:

- 8 track/3 carrier rollers (Each side)
- Hydraulic track adjusters (Each side)
- Rock protectors
- Sealed track
- Track shoe:  
—610 mm double grouser
- Variable track gauge

### GUARDS AND COVERS:

- Dust-proof net for radiator and oil cooler
- Full length track roller guard
- OPG top guard level 2 (ISO 10262)
- Pump/engine room partition cover
- Strengthened revolving frame underguard
- Travel motor guards

### OPERATOR ENVIRONMENT:

- Cab with fixed front window

- Damper mount, all-weather, sound-suppressed cab with tinted safety glass windows, lockable door, intermittent window wiper and washer, floormat, cigarette lighter and ashtray
- Multi-function color monitor, electronically-controlled throttle dials, electric service meter, gauges (Coolant temperature, hydraulic oil temperature and fuel level), caution lights (Electric charge, engine oil pressure, and air cleaner clogging), indicator lights (Engine preheating and swing lock light) level check lights (Coolant, engine oil, and hydraulic oil level), self-diagnostic system with trouble data memory
- Rear view mirror (RH and LH)
- Seat, fully adjustable with suspension

### HYDRAULIC CONTROLS:

- Control levers and pedals for steering and travel with PPC system
- Control levers, wrist control levers for arm, boom, bucket, and swing with PPC system
- Fully hydraulic, with Electronic Open-center Load Sensing System and engine speed sensing (Pump and engine mutual control system)
- Heavy lift mode system
- In-line filter
- Oil cooler
- One axial piston motor per track for travel with counter balance valve
- Power max function

- Shockless boom control
- Swing priority mode system
- Two axial piston motors for swing with single-stage relief valve
- Two control valves, 5+4 spools (Boom, arm, bucket, swing, and travel)
- Two-mode setting for boom
- Two variable capacity piston pumps

### DRIVE AND BRAKE SYSTEM:

- Brakes, hydraulic lock travel brakes, oil disc parking
- Hydrostatic two travel speed system with planetary triple reduction final drive

### OTHER STANDARD EQUIPMENT:

- Automatic swing holding brake
- Catwalk
- Counterweight, 11850 kg
- Horn, electric
- Large handrails
- Marks and plates, English
- One-touch engine oil drainage
- Paint, Komatsu standard
- Preventive Maintenance (PM) tune-up service connector
- Rear reflector
- Slip-resistant plates
- Travel alarm
- Water separator



## OPTIONAL EQUIPMENT

- 12 V electric supply
- Alternator, 24 V/90 A
- Arms:  
PC850-8R1:  
—3600 mm arm assembly  
PC850-8R1 SE spec.:  
—2945 mm SE arm assembly  
—3600 mm SE arm assembly
- Attachment piping specification equips for breaker installation (For PC850-8R1 SE spec. \*)
- Automatic air conditioner (A/C)

- Booms:  
PC850-8R1:  
—8040 mm boom assembly  
PC850-8R1 SE spec.:  
—7100 mm SE boom assembly
- Cab front guard level 2 (ISO 10262)
- Coolant heater
- Double flange track roller
- Electric pump, grease gun with indicator
- Fire extinguisher
- General tool kit
- Interconnected horn and warning light

- Large-capacity batteries
- Lower wiper
- Provision for fast fuel fill
- Radio AM/FM
- Rain visor
- Rear view monitor system
- Seat belt 78 mm, 50 mm
- Spare parts for first service
- Track frame undercover (Center)
- Track shoe:  
—710 mm double grouser
- Vandalism protection locks

\*1 Special Features Request required for Komatsu authorization by application.

Up to 20% blended biodiesel fuel and paraffine fuel can be used. Please consult your Komatsu distributor for detail.

<https://home.komatsu/en/>

Printed in Japan 202104 IP.As