

Technical paper

Development of  $\phi$ 170 Engines Conforming to Tier4 Final Emissions Regulations

Issei Hara

Tetsuo Orita

To conform to the Tier4 Final emissions regulations, which has been enforced since January 2014 and January 2015, it became necessary to significantly reduce the amount of nitrogen oxides (NOx) and particle matter (PM) than the former regulations. To meet the more restrictive emissions regulations while maintaining the performance, reliability, and durability of the engine equivalent to or even better than the existing products, we have developed and succeeded in productizing a new series of 23 L class engines, featuring Tier4 Final overcoming technologies.

**Key Words:** Construction equipment, Diesel engine, Emissions regulations, Tier4 Final, Aftertreatment device

1. Introduction

With its excellent thermal efficiency as well as high reliability and durability, and wide range of power obtained for equipment ranging from small to large sized ones, diesel engine has been widely used in the industry. However, impacts of nitrogen oxides (hereinafter referred to as NOx) and suspended particulate matters (hereinafter referred to as PM) in the emissions on the environment and human body have been pointed out. Among them, specifically for diesel engine for construction equipment, emissions regulations have been enhanced across the world since 1996. In particular, the emissions regulations have been driven by the regulation levels led by three regions, i.e. Japan, U.S. and Europe.

To make engines in the power range from 130 kW to 560 kW conform to the U.S. EPA Tier4 Final Emissions Regulations enforced since January 2014, the EU Stage IV, and the Japanese Off-road Emissions Regulations enforced since October 2014, and engines above 560 kW conform to the U.S. EPA Tier4 Final Emissions Regulations enforced since January 2015 (hereinafter the underlined parts are referred to as “Tier4 Final emissions regulations”), we applied technologies required to meet the Tier4 Final emissions regulations, which had been adopted for previously developed models ( $\phi$ 125 and  $\phi$ 140 engines), to the  $\phi$ 170 engines (23 L), and succeeded in its development and commercialization. In

this paper, an outline of the  $\phi$ 170 engines (23 L) conforming to Tier4 Final emissions regulations, and its technical characteristics are introduced.

2. Emissions regulations trend in diesel engine for construction equipment

Along with introduction of the Tier4 Final emissions regulations in 2014, emissions regulations for diesel engine for construction equipment have stepped into a new stage. In Fig. 1, the trend of emissions regulations in Japan, U.S., and Europe is shown by organizing year by year.

		NOx / PM, *NOx-NMHC / PM, **NOx+HC / PM (g/kWh)														
kW		2004	2005	2006	2007	2008	2009	2010	2011	2012	2013	2014	2015	2016		
JAPAN	19...<37	8.0/0.80			6.0/0.4			4.0/0.2			4.0/0.25					
	37...<56	7.0/0.40			4.0/0.3			3.3/0.025			4.0/0.025					
	56...<75	7.0/0.4			4.0/0.25			3.3/0.025			4.0/0.025					
	75...<130	6.0/0.30			3.0/0.2			3.3/0.025			0.4/0.02					
JAPAN	130...<560	6.0/0.25			3.0/0.17			3.0/0.02			0.4/0.02					
US	<19	8.0/0.4		7.5/0.8		7.0/0.4		7.0/0.4		7.0/0.4		7.0/0.4		7.0/0.4		
	19...<37	7.0/0.6		7.0/0.6		7.0/0.6		7.0/0.6		7.0/0.6		7.0/0.6		7.0/0.6		
	37...<56	7.0/0.4		7.0/0.4		7.0/0.4		7.0/0.4		7.0/0.4		7.0/0.4		7.0/0.4		
	56...<75	7.0/0.4		7.0/0.4		7.0/0.4		7.0/0.4		7.0/0.4		7.0/0.4		7.0/0.4		
	75...<130	6.0/0.3		6.0/0.3		6.0/0.3		6.0/0.3		6.0/0.3		6.0/0.3		6.0/0.3		
US	130...<560	6.0/0.2		6.0/0.2		6.0/0.2		6.0/0.2		6.0/0.2		6.0/0.2		6.0/0.2		
US	>560	5.2/0.54		6.0/0.2		6.0/0.2		6.0/0.2		6.0/0.2		6.0/0.2		6.0/0.2		
EU	19...<37	8.0/0.8			7.0/0.6			7.0/0.6			7.0/0.6					
	37...<56	7.0/0.4			4.7/0.4			4.7/0.4			4.7/0.025					
	56...<75	7.0/0.4			4.7/0.4			4.7/0.4			4.7/0.025					
	75...<130	6.0/0.3			4.0/0.3			4.0/0.3			4.0/0.025					
EU	130...<560	6.0/0.2			4.0/0.2			4.0/0.2			4.0/0.025					
		Tier1			Tier2			Tier3 / Stage 3B			Tier4 Int. / Stage 3B			Tier4 Final / Stage 4		

Fig. 1 Emissions regulation values in Japan, U.S. and Europe

Fig. 2 shows the transition from Tier1 to 4 based on values of emissions regulation values for NOx and PM by taking up the U.S. EPA regulations (130 kW-560 kW) as a typical example. With each regulation stage increasingly strengthened every five years, regulation values for main substances such as NOx and PM are required to be reduced by a level approximately 30% each.

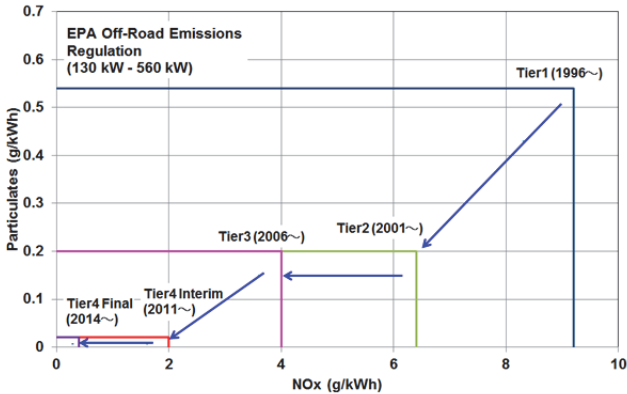


Fig. 2 U.S. EPA Emissions Regulations values (130 kW-560 kW)

For the engines in the power category from 130 kW to 560 kW of the Tier4 Final Emissions Regulations, they are required to conform to the emissions regulations of Japan, U.S. and Europe, and NOx and PM are required to be reduced to 1/10 of Tier3 regulation values, respectively. While there is no regulation in Japan and Europe for engines above 560 kW at this time, they are required to conform to U.S. emissions regulations, and the values of NOx and PM are required to be reduced to 1/2 and 1/5 respectively of the regulation values in Tier2.

With significantly strict regulation values specified for NOx and PM in both categories, it is dispensable to adopt aftertreatment devices.

As an emissions measurement mode of diesel engine for construction equipment, a steady state 8-mode called C1 mode in ISO 08178 has been adopted conventionally.

For the engines in the power category from 130 kW to 560 kW, a measurement mode for a transient state called “non-load transient cycle” has been added since a new regulation was enforced in 2011, and it is required for measurement results by both modes to conform to regulation values, respectively. Measuring method for emissions of diesel engine for construction equipment is shown in Fig. 3. For engines above 560 kW, it is required to adopt the emission measurement method based on steady state 8-mode as before.

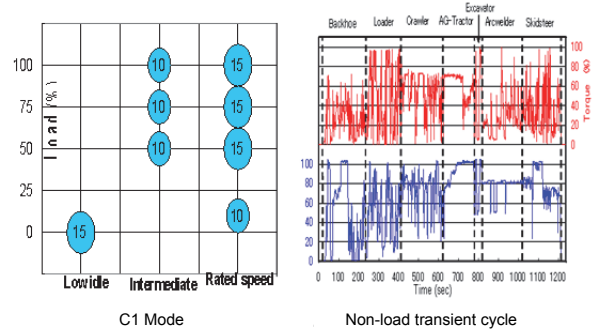


Fig. 3 Emission measurement method for construction equipment engine (130 kW-560 kW)

High precision control of PM and NOx aftertreatment devices is required to meet the Tier4 Final emissions regulations, in particular in the non-load transient cycle measurement mode.

### 3. Outline of Tier4 Final Compliant φ170 Engine Series

#### (1) Outline of φ170 engines (23 L)

As described above, Tier4 Final emissions regulations have been enforced for engines in the power range from 130 kW to 560 kW in three regions; in U.S. and Europe since January 2014 and in Japan since October the same year. For engines above 560 kW, Tier4 Final emissions regulations have been enforced in U.S. since January 2015. Among the engine series developed to meet Tier4 Final emissions regulations in response to enforcement of the regulations, the φ170 engines (23 L) are introduced here.

Fig. 4 shows the displacement and power range of the φ170 engine series. In addition, Fig. 5 shows a typical example of construction equipment application mounted with this engine.

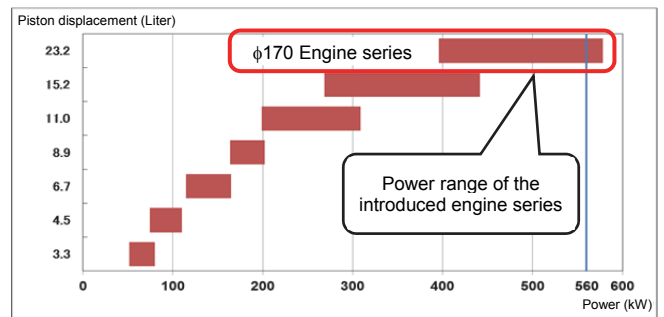


Fig. 4 Displacement and power of engine series



Fig. 5 Typical examples of construction equipment applications

Table 2 Main incorporated technologies for 23 L class engines

Corresponding exhaust gas regulations		Tier3	Tier4 Final compatible (560 kW or less)	Tier4 Final compatible (larger than 560 kW)
Engine model	unit	SAA6D170E-5	SAA6D170E-7	SAA6D170E-7
Number of cylinders	—	6		
Bore×stroke	mm×mm	170×170		
Piston displacement	Liter	23.15		
Fuel injection system	—	Common rail system	Common rail system (2-supply pump)	
Maximum fuel injection pressure	MPa	160	200	
Turbocharger	—	Fixed	Variable	
Exhaust Gas Recirculation	—	Equipped (multi-tubular)	Equipped (fin & tube)	
Engine controller	—	CM850	CM2350	
Blowby gas treatment	—	Atmosphere release	Suction reduction	
Aftertreatment device	—	None	Komatsu Diesel Particulate Filter + Selective Catalytic Reduction	Komatsu Diesel Particulate Filter

- (2) Purposes of development of engines conforming to Tier4 Final emissions regulations
  - (a) Conformity with Tier4 Final emissions regulations in three regions, i.e. Japan, U.S. and Europe.
  - (b) Achieve a fuel consumption equivalent to or lower than that of a previous engine, in consideration of urea solution consumption (engines in the power range from 130kW to 560kW).
  - (c) While minimizing modification of base engine, apply technologies used for other Tier4 Final KOMATSU engines.
  - (d) Ensure reliability and durability as an engine for construction equipment under severe environments and usage.

Table 1 shows the transition of emissions regulations and the incorporated technologies Table 2 shows the main technologies incorporated for achieving the targets of this development.

Table 1 Transition of emissions regulations and incorporated technologies

Exhaust gas regulations	Compatible technology
Tier2 compatible	(1) Air cooling aftercooler + (2) High pressure injection (unit injector)
Tier3 compatible	(1) Air cooling aftercooler + (2)* High pressure injection (160 MPa compatible) + (3) Exhaust gas recirculation
Tier4 Final compatible (560 kW or less)	(1) Air cooling aftercooler + (2)** High pressure injection (200 MPa compatible) + (3)* Exhaust gas recirculation + (4) Variable turbocharger + (5) Komatsu diesel particulate filter + (6) Selective catalytic reduction
Tier4 Final compatible (Larger than 560 kW)	(1) Air cooling aftercooler + (2)** High pressure injection (200 MPa compatible) + (3)* Exhaust gas recirculation + (4) Variable turbocharger + (5) Komatsu diesel particulate filter

The development of the φ170 engines eventually became a project to make a Tier3 compliant engine meet the Tier4 Final emissions regulations in a short period of three years. Therefore, a proven technology adopted in other KOMATSU engines was used to make the engine compliant to the Tier4 Final emissions regulations.

In addition, since the φ170 engines are used for large sized construction equipment and their unique two-supply pump common rail fuel injection system and the two-line aftertreatment devices became significant development elements, it took a lot of time to secure performance, reliability and durability equal to or more than those of previous engines as well as to confirm the quality.

The key technologies adopted include: Increased injection pressure of the electronic controlled common rail system, variable geometry turbocharger, high precision control of exhaust gas recirculation (EGR) valve, increased capacity of the exhaust gas recirculation (EGR) cooler, and the blowby gas intake reduction system (Komatsu Closed Crankcase Ventilation: KCCV) which returns blowby gas to intake air without releasing into the atmosphere.

The SAA6D170E-7 engine for wheel loaders up to 560 kW is shown in Fig. 6, and the version for dump trucks above 560 kW is shown in Fig. 7.

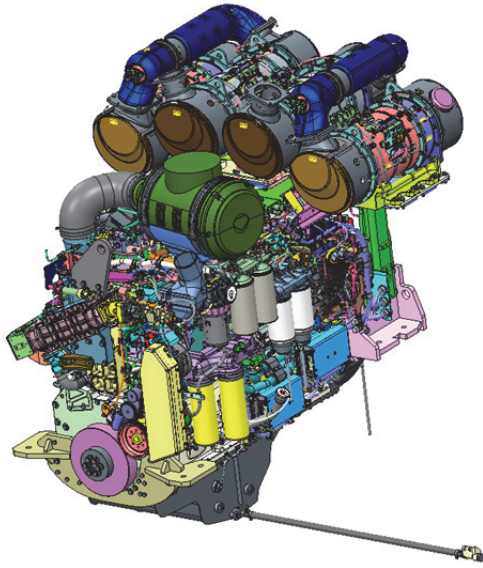
#### 4. Engine technologies conforming to Tier4 Final emissions regulations

Explained below are the key components used on the  $\phi 170$  engines developed this time to ensure performance (power and fuel consumption) equivalent to or superior to that of previous engines while making the engines meet all of the latest emissions regulations in Japan, U.S. and Europe, as set as a goal of this development.

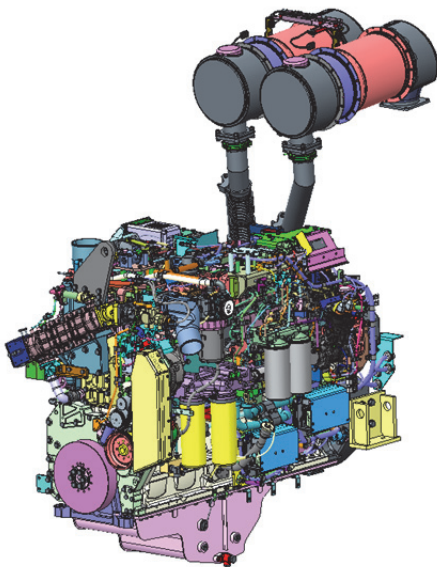
##### (1) Fuel injection system

Development of the  $\phi 170$  engines incorporated NOx reduction measures based on increased EGR efficiency, in order to meet the Tier4 Final emissions regulations which is stricter by two stages while keeping the power and fuel consumption performances equivalent to or superior to those of previous engines, as described previously. An electronic control type common rail system with a maximum injection pressure of 200 MPa has been adopted, and a performance tuning was performed in combination with a new combustion chamber shape (Two Stage Combustion Chamber: TSCC) which was adopted in advance of other engine series since the time of Tier3 regulations.

When increasing the pressure of the common rail system, the discharge capability of the supply pump became a technical hurdle. Since the piston displacement per cylinder of a  $\phi 170$  engine is large, the fuel injection quantity is large. When the injection pressure is increased from the previous 160 MPa to 200 MPa, the discharge capability of a single pump will be insufficient, so two pumps are used. **Fig. 8** shows a comparison of the injection quantity per cylinder of large sized engines.

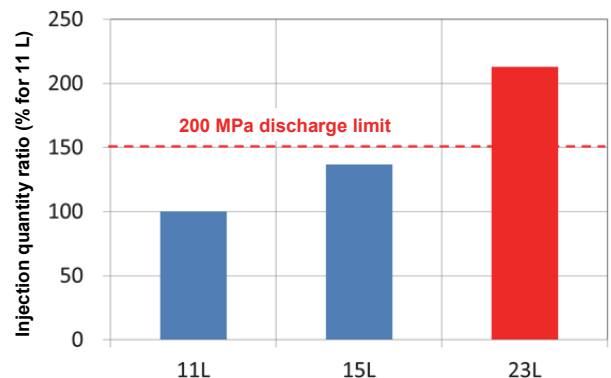


**Fig. 6** SAA6D170E-7 engine conforming to Tier4 Final (up to 560 kW)



**Fig. 7** SAA6D170E-7 engine conforming to Tier4 Final (above 560 kW)

**Injection quantity ratio at rating point (11 L vs 15 L vs 23 L)**



**Fig. 8** Comparison of fuel injection quantity per cylinder

The two-supply pump common rail system has achieved stable control by driving each supply pump using two cooperating engine control units (ECU). High injection quantity and pressure is realized by collecting the fuel discharged from each supply pump to one common rail before distributing the fuel to each cylinder. Since the NOx and PM have been reduced by these combustion improvement measures as described above before applying the aftertreatment devices capable of satisfying emission regulation values at the rated power, we succeeded in making the engine performance meet the Tier4 Final emission regulations as an engine system. Fig. 9 shows the configuration of a two-supply pump common rail system.

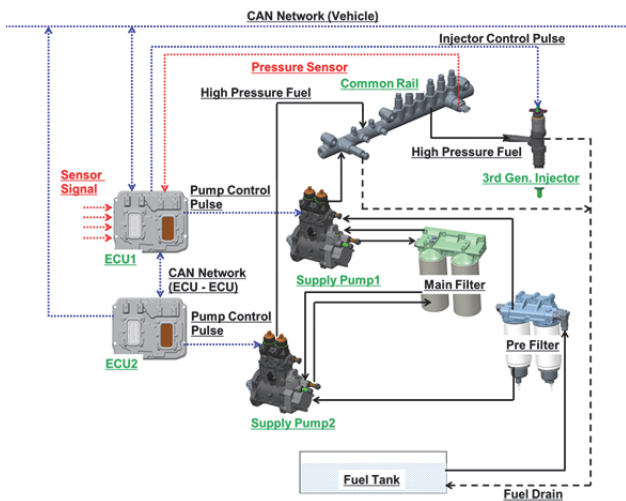


Fig. 9 Two-supply pump common rail system schematic

Moreover, in case of applications with a Selective Catalytic Reduction (SCR) system, the consumption of urea solution results in cost increase for the customer. A tuning was performed to reduce the fuel consumption so that total of fuel and urea solution consumption will be equal to or less than the fuel consumption of previous engine. Fig. 10 shows comparisons of fuel consumption at a rating point between applications with a new  $\phi 170$  engine and an previous engine.

$\phi 170$  Engine fuel consumption comparison

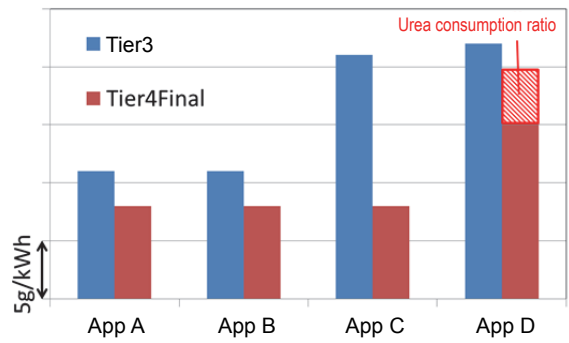


Fig. 10 Comparison of fuel consumption between applications equipped with a  $\phi 170$  engine (Tier3 vs Tier4 Final)

(2) Exhaust Gas Recirculation Valve (EGR valve)

A hydraulically driven system with an additional hydraulic servo mechanism, which has been adopted to other KOMATSU engines conforming to Tier4 Final emissions regulations, was adopted to the EGR Valve. Fig. 11 shows the appearance of the EGR valve which features compactness, high precision and high reliability.

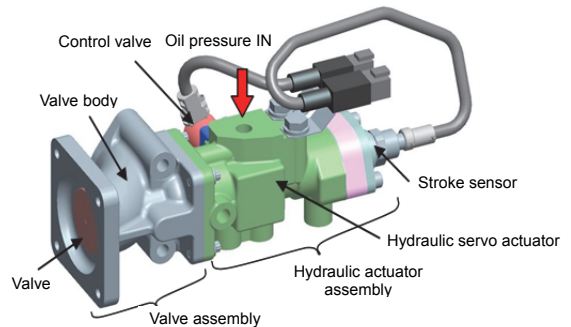


Fig. 11 Appearance of the EGR valve

(3) Exhaust Gas Recirculation Cooler (EGR Cooler)

It is important to sufficiently reduce the temperature of a large quantity of EGR gas to significantly reduce NOx. Therefore, the previous multi-tubular type cooler was replaced by a fins & tubes type, featured with fins inside a flat tube which functions as the EGR gas passage.

Fig. 12 shows the appearance and structure of the large capacity EGR cooler adopted to conform to Tier4 Final emissions regulations.

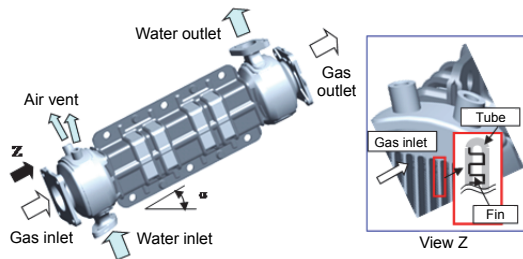


Fig. 12 Appearance and structure of the EGR cooler

(4) Variable geometry turbocharger

For the variable geometry turbocharger, a mechanism to adjust the passage width by sliding a slide type nozzle was adopted, which has been adopted to other KOMATSU engines conforming to Tier4 Final emissions regulations. A new variable geometry turbocharger with a size matching to the engine displacement has been developed.

In addition, a hydraulic driving system based on our own technology was adopted similarly to the EGR valve as described above.

As a result of adopting a variable geometry turbocharger, EGR has become possible within a wide operation range, contributing to significant improvement in product performance, by reducing fuel consumption and allowing for distribution to acceleration performance. Fig. 13 shows the configuration of a variable geometry turbocharger.

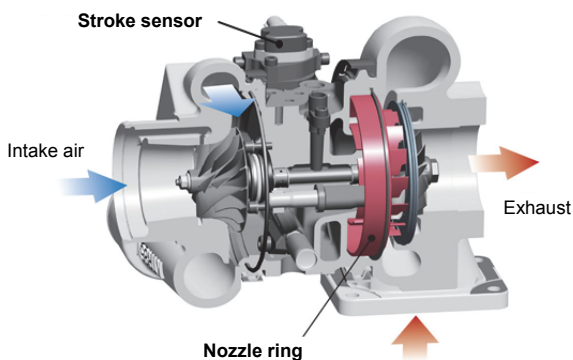


Fig. 13 Configuration of a variable geometry turbocharger

(5) Komatsu Closed Crankcase Ventilation: KCCV

Komatsu Closed Crankcase Ventilation system, which had been used on other KOMATSU engines conforming to Tier4 Final emissions regulations, was adopted.

The compact and highly reliable KCCV filter is housed in an aluminum body with high rigidity suitable for usage on construction equipment, equipped with a pressure regulation valve to prevent the crankcase from being depressurized by negative pressure of turbo intake, and has a pressure sensor to detect clogging of the filter. Fig. 14 shows the appearance of the KCCV.

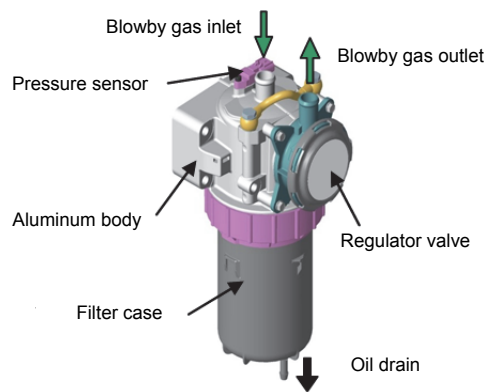


Fig. 14 Appearance of KCCV

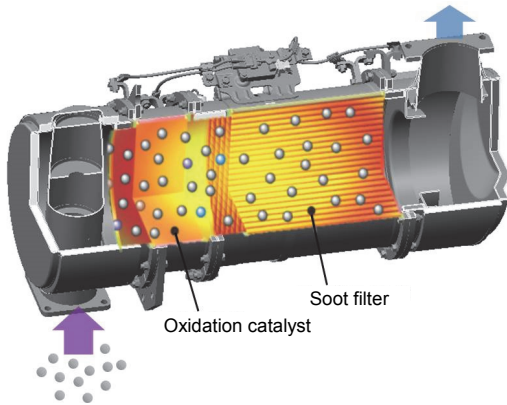
5. Aftertreatment device

In order to meet the Tier4 Final emissions regulations, a Komatsu Diesel Particulate Filter (KDPF) for removing soot from emissions and a Urea Selective Catalytic Reduction (SCR) system to reduce NOx to 1/10 or less are adopted in combination according to the engine power.

The aftertreatment devices for φ170 engines are commonalized with those developed for the φ125 engines and φ140 engines, and are mounted as a two system aftertreatment devices, like the SAA6D170E-7 engine conforming to the Tier4 Final regulations, as shown in Fig. 6 and 7.

The two-system aftertreatment devices are controlled in a cooperative manner but diagnosed for faults separately and they can be monitored independently for their conditions. In this way the reliability and serviceability of the devices are improved.

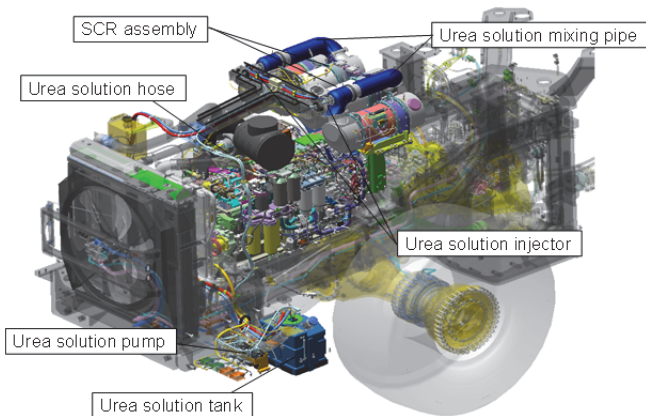
- (1) Komatsu Diesel Particulate Filter (KDPF)  
**Fig. 15** shows the internal structure of the KDPF.



**Fig. 15** KDPF configuration

The KDPF is a continuous regeneration type filter system in which an oxidation catalyst is placed at the stage before a soot filter with a catalyst, capable of burning soot continuously during normal operation. It is also equipped with a control system to automatically detect soot (that can accumulate during operation in low temperature environments or under light load conditions) by a controller and forcibly regenerate the filter. This makes the system possible to deal with various usages.

- (2) Urea Selective Catalytic Reduction System (SCR)  
**Fig. 16** shows how the urea SCR system is mounted.



**Fig. 16** Mounting of the urea SCR system

The urea solution pump and urea solution injector which are located ahead of the urea solution tank consist of a two-line system, and the urea solution injected from each urea solution injector is led through the urea solution mixing piping to the SCR assembly with a built-in SCR catalyst.

- (3) Urea solution supply system

The urea solution supply system consists of a urea solution tank, urea solution pump, and urea solution injector.

The urea solution pressurized by the urea solution pump and is injected by the urea solution injector into the exhaust gas. The urea solution is always controlled at an appropriate injection quantity according to the engine operating conditions and the SCR assembly conditions.

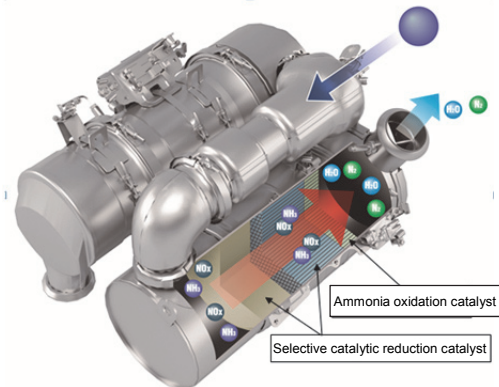
Since the urea solution will freeze at  $-11^{\circ}\text{C}$ , the urea solution tank, the urea solution pump and urea solution hose are provided with a heater to thaw and keep-warm the urea solution in low temperature environments.

- (4) Urea solution mixing piping

The urea solution mixing piping is designed in a way to let the urea solution injected into the exhaust gas to break down into ammonia, etc. and spread into the exhaust gas evenly.

- (5) Selective Catalytic Reduction (SCR) Assembly

**Fig. 17** shows the internal structure of the SCR assembly.



**Fig. 17** Internal structure of the SCR assembly

The SCR assembly consists of a SCR catalyst and an ammonia oxidation catalyst placed at the downstream. In the SCR catalyst, the NOx in the exhaust gas reacts selectively with ammonia broken down from the urea solution, and then the NOx breaks down into harmless nitrogen and water. The state of the SCR assembly is always monitored by a built-in sensor during the operation to optimize the control and achieve both NOx reduction and prevention of discharge of excess ammonia, that was leftover from the SCR reaction.

These aftertreatment devices are designed to ensure sufficient reliability and durability even when used on construction equipment operating in severe environments, in which the machines are subjected to large impact loads. In particular, the quality of the urea mixing piping, SCR assembly and KDPF are assured by manufacturing them in-house.

## 6. Electronic control system

A newly developed ECU is used in the electronic control system in order to control the electronic control common rail injection system, variable geometry turbocharger, KDPF and urea SCR system which were adopted to make the engines Tier4 Final regulations compliant.

In this engine series, two ECUs controlled by a dedicated software cooperate with each other to stably drive the two-supply pump common rail system, and let the two-line aftertreatment devices uniformly purify the exhaust gas.

A new fault diagnostic system for the engine and aftertreatment devices conforming to the Tier4 Final emissions regulations, especially to the power restriction by SCR inducement has been newly introduced. This system enables each ECU to cooperate with each other to perform advanced troubleshooting of the entire system.

## 7. Reliability and Durability

In developing the  $\phi 170$  engine series conforming to Tier4 Final emissions regulations, we applied the Tier4 Final compliant technologies adopted to the previously developed models to this new large engine series. We conducted a sufficient number of reliability and durability tests by setting evaluation criteria for applications of large engines, in order to not only satisfy all the previous quality check codes for industrial engines, but also to achieve a high quality, and satisfy the newly added evaluation test codes for the Tier4 Final regulations compliant technologies.

To confirm the durability of the aftertreatment devices, in adopting the KDPF and urea SCR system, the vibration and shock acceleration of the actual machine was evaluated for all construction equipment applications on which the devices will be installed, and evaluation conditions covering all applications have been set up.

Regarding the engine durability tests, in order to confirm stable functioning of the KDPF system and urea SCR system and optimal setting of the newly developed control parameters, we conducted cycle operation durability tests by simulating typical operating conditions expected in each application, based on measurement data of actual machines. We also carried out a sufficient number of tests to confirm the soot accumulation and urea deposit formation.

For the Tier4 Final compliant  $\phi 170$  engines (23 L) developed this time, the reliability and durability of the engines have been sufficiently verified by conducting bench duration test for more than 15,000 hours and practical tests on machine for more than 5,000 hours in total.

## 8. Conclusion

The outline of the newly developed  $\phi 170$  engines (23 L) conforming to the Tier4 Final emissions regulations and their technical characteristics have been introduced.

We developed most of the key components to make the engines Tier4 Final compliant by ourselves, and many of them are manufactured in-house. We believe that we have succeeded in introducing a Tier4 Final emissions regulations compliant engine series which not only satisfies the needs of the construction equipment market, but also differentiated from our competitors' products.

We also believe that we succeeded in not only observing low fuel cost, reliability and durability of the whole machine as the company's characteristics, but also finishing a product with high quality, friendly to the environment.

### [References]

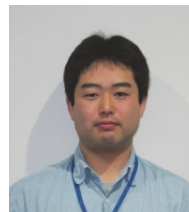
- “Kensetsu no sekou kikaku magazine: Technologies conforming to emissions regulations in Japan, U.S. and Europe”
- “Komatsu Technical Report: Development of  $\phi 125/\phi 140$  Engines Conforming to Tier4 Final Regulations”
- “Kensetsu Kikai Sekou (Journal of JCMA): Development of Engines Conforming to Tier4 Final Emissions Regulations”

### Introduction of the writers



#### Issei Hara

Joined Komatsu Ltd. in 2008.  
Industrial Power Alliance, Ltd.  
Medium and large sized engine design group



#### Tetsuo Orita

Joined Komatsu Ltd. in 2001.  
Industrial Power Alliance, Ltd.  
Medium and large sized engine design group

### [A comment from the author]

As engines conforming to Tier4 Final have been already brought into the market, it is our concern how they are evaluated in the market.