

Introduction of Product

Introduction of Large Wheel Loader WA500-6

Yasushi Hatanaka

Kenji Misuda

Kentarou Itou

As changing of models of the Wheel Loader WA500-3, WA500-6 has been developed featuring “Dantotsu” performance, upgraded vehicle classification and regulation compliance. The features of the new model are described.

Key Words: WA500-6, wheel loader, EPA tier-3 exhaust gas regulation, EU tier-3 exhaust gas regulation, EU Stage 2 noise regulation, “Dantotsu,” low fuel consumption, vehicle classification, upgraded vehicle classification, Hydrau MIND system, lock up clutch, lock up torque converter, automobile registration

1. Introduction

First introduced to the market in 1996, the WA500-3 was modified in 2001 to comply with the Tier-2 exhaust gas regulation. During this time, the durability and productivity of the model were highly evaluated by many users.

Nevertheless, a full model change was undertaken to challenge the upgraded specifications of competing machines through model changes and resultant increases in the size and in the range of loading dump trucks, as well as to comply with the Tier-3 exhaust gas regulation beginning to be enforced in 2006 and the EU Stage 2 noise regulation.

At the same time, seizing this model change as an opportunity, the WA500-6 was introduced to a market incorporating Komatsu’s comprehensive capability and state-of-the-art technology and featuring “Dantotsu” economy and high productivity, a traditional feature of the Komatsu wheel loaders as reported below.



Photo 1 WA500-6

2. Aims of Development

In the field, the match between loading equipment and dump trucks is changing. In response to these field needs, the WA500-6 has been designed and built to best match up to 32-ton dump trucks, instead of only from on-load dump trucks to 25-ton trucks (Fig. 1).

For this purpose, vehicle classification was upgraded by optimizing the bucket capacity and engine horsepower (Table 1).

At the same time, the basic concepts of Komatsu, namely, economy, safety, environmental friendliness and IT, were implemented by incorporating state-of-the-art technology to enhance the product power.

A reduction in fuel consumption, which accounted for a large portion of the O&O cost, was selected as a “Dantotsu” feature.

Table 1 Upgraded vehicle classification

	Unit	KOMATSU		CAT	Volvo
		WA500-6	WA500-3	980H	L220E
Bucket capacity	m ³	5.6	5.0	5.4	5.6
Engine horsepower (ISO 9249)	hp	332	316	318	334
Vehicle weight	ton	32.5	29.4	30.5	31.4
Vehicle classification value *)	-	39.2	35.9	37.4	38.9

$$* : \sqrt[3]{(\text{Bucket capacity}) \times (\text{engine horsepower}) \times (\text{vehicle weight})}$$

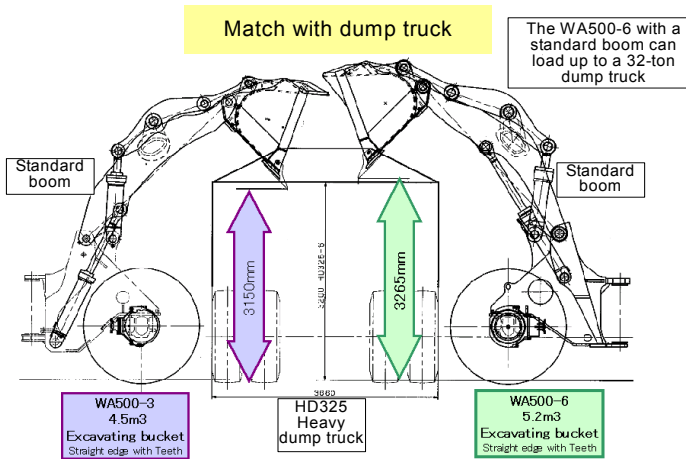

Fig. 1 Match with dump truck

Table 2 Development objectives and means to accomplish them

	Objective	Means to accomplish
Economy	Increase in work rate <ul style="list-style-type: none"> • Loading work • L&C work • Travel between sites Reduced fuel consumption	Upgraded vehicle classification <ul style="list-style-type: none"> • Larger dump truck size (wider range), enhanced work efficiency <ul style="list-style-type: none"> On-load dump truck to 25-ton dump truck → On-load dump truck to 32-ton dump truck Larger bucket capacity, larger dumping clearance, larger traction • 6.3m stockpiler bucket that can fully load on load dump truck with 1 time Improved travel performance <ul style="list-style-type: none"> Enhanced uphill traveling speed Low-speed matching (large-capacity torque converter + low revolutions, high torque engine) <ul style="list-style-type: none"> • Variable-capacity pump + CLSS (work equipment, steering circuit) • Engine output 2-mode system (Modes P and E) • Automatic transmission gear shift point 2-mode system (Modes H and L) • Eco indicator • Torque converter with lock up clutch (Japan, standard specification; outside of Japan, optional)
Safety	Operator fatigue mitigation <ul style="list-style-type: none"> Enhanced visibility 	Work equipment operation <ul style="list-style-type: none"> • EPC lever (fingertip control) <ul style="list-style-type: none"> Reduced operation force + shorter operation stroke Auto operation: Remote boom, bucket positioner, semi-auto digging • Transmission gear shift operation: Automatic transmission • Steering operation: Joystick steering (option) • Dwelling space: Low noise, high pressurized cab • With large glass panes on all sides, integral ROPS cab • Improved front visibility (High mount cab) • Improved rear visibility (Shorter rear invisibility distance, rear-underview mirror)
Environment	Compliance with next-tier exhaust gas regulation (Japan, USA, Europe) <ul style="list-style-type: none"> Compliance with EU Tier-2 noise regulation Reduction of hazardous substances 	eco3 engine <ul style="list-style-type: none"> • Variable-capacity fan pump + hybrid fan • Sound isolation of engine room • Aluminum core radiators
IT	Easy trouble diagnosis <ul style="list-style-type: none"> Central management of information 	EMMS (Main monitor) <ul style="list-style-type: none"> KOMTRAX2

3. Principal Features

3.1 Increase in Work Rate

(1) Enhanced loading work efficiency

- The vehicle classification has been upgraded compared with conventional machine WA500-3, allowing loading of a 32-ton dump truck in four loadings by a standard wheel loader. Compared with conventional machines, dump trucks can be loaded full with fewer loading operations. This allows enhanced productivity per hour (shorter time to fully load a dump truck and lower fuel consumption).

Table 3 Dump truck matching loading operations (weight)

• Bucket type: SE (straight edge), SN (spade nose) = pointed lip

		WA500-3	WA500-6	980H	L220E
On-load dump truck	Japan	11ton	2SP	2SP	2SP
	USA	~21.5ton	3SP	3SP	3SP
	Europe	~38.0ton	5HL	4SP	5SP
Articulated dump truck	HM400-1	40.1ton	5SP	5SP	5SP
	HM350-1	35.6ton	5SP	4SP	4SP
	HM300-1	29.9ton	4SP	4SP	4SP
	HM250-1	27.0ton	4SP	3SP	3SP
Rigid dump truck	HD405-6	40ton	6HL	5HL	5HL
	HD325-6	32ton	5HL	4EX	4HL
	HD255-5	25ton	3EX	3EX	3EX

Light blue box: Matching with fewer loading operations compared with existing machines
 Pink box: Matching with fewer loading operations by competing machines with existing machines

EX: Standard boom and digging bucket. SP: Standard boom and product loading bucket. HL: High lift boom and digging bucket

Whereas medium-size machines and the conventional machine WA500-3 have to load a commercial dump truck (11-ton capacity) 2 or 3 times, only one loading operation fully loads a dump truck in one operation when a stockpile bucket (6.3 m) is used, drastically enhancing work efficiency.

(2) Enhanced loading and carrying work efficiency and efficiency in traveling between sites

Optimizing a match between the torque converter and engine, traveling performance in a medium-speed region has been enhanced, improving uphill traveling speed. This allows time reduction in loading and carrying operation on roads including uphill roads and traveling between sites (Fig. 5).

3.2 Low Fuel Consumption

The following five items were incorporated as means to reduce fuel consumption.

(1) The torque converter and engine were matched so that the zone in which the wheel loader is operated frequently under a large load and the high fuel efficiency zone of the engine

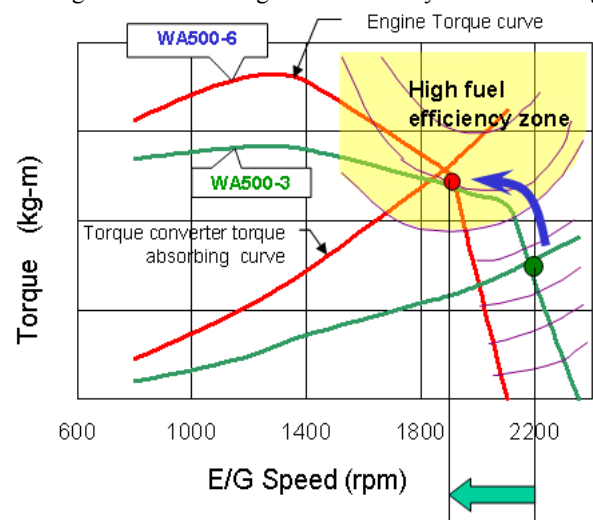

match (Fig. 2).

Fig. 2 Matching of engine and torque converter

(2) Hydraul MIND system

The combination of a variable displacement piston pump and CLSS (closed-circuit load-sensing system) is adopted in the work equipment and steering circuit, to drastically reduce hydraulic pressure losses compared with the fixed-capacity pump system of conventional machines (Fig. 3).

Hydraulic pressure is needed during digging, but the oil quantity can be small. By controlling to make the pump discharge only the needed oil quantity, hydraulic horsepower consumption during digging is reduced.

In work equipment control, control thoroughly eliminates hydraulic horsepower other than the hydraulic horsepower that is needed in flow rate cut and relief cut in zones other than above the horizontal position of the boom.

A hydraulic drive fan in combination with a variable displacement piston pump is adopted for the engine fan, reducing hydraulic horsepower consumption.

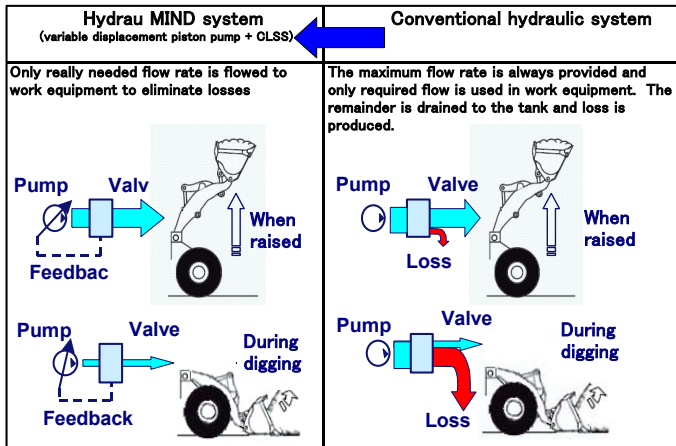

Fig. 3 New hydraulic system

(3) Duel mode power select system

A system to allow the selection of engine output from two modes (Modes P and E) is adopted.

Mode E is set so that the lack of power with conventional Mode E is not felt. The system allows the performance of normal work that is equivalent to work accomplished by competing machines with lower power consumption in Mode E. Mode P is set especially for a large work rate that has to be accomplished in a short time.

This could be achieved by optimizing the match between a large-capacity torque converter and engine and by tuning of work equipment control. Normal work is back to default setting so that it is operated in Mode E for energy saving.

Modes E and P can be selected easily by the one-touch operation of a switch (Fig. 4★1).

(4) Selection of two automatic transmission gear shift points (Modes H and L)

The system allows selection of automatic gear shift-suiting conditions of the traveling road and work mode (Fig. 4★2).

Mode L is selected for work and travel on normal flat sites and on traveling roads to reduce fuel consumption.

In case work is slow by normal automatic transmission on a steep uphill road or when an uphill road is long or the smoothness of travel speed is impaired by frequent gear shift changes, Mode H is selected to increase gear shift point to allow quick and smooth traveling.

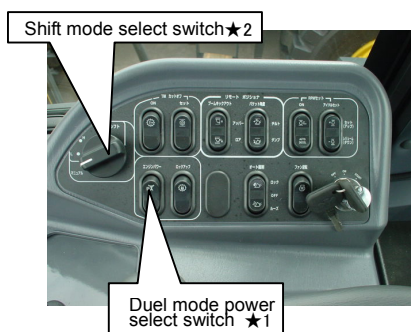

Fig. 4 Shift mode select switch

(5) Torque converter with lock up clutch

A lock up torque converter is available to enhance travel performance and fuel consumption in loading and carrying operations at a high travel mode ratio and when traveling between sites (This specification is a standard specification for some destinations).

To further demonstrate the effect of the lock up torque converter, the lock up function is activated by changing from 2nd gear to 4th gear (Fig. 5).

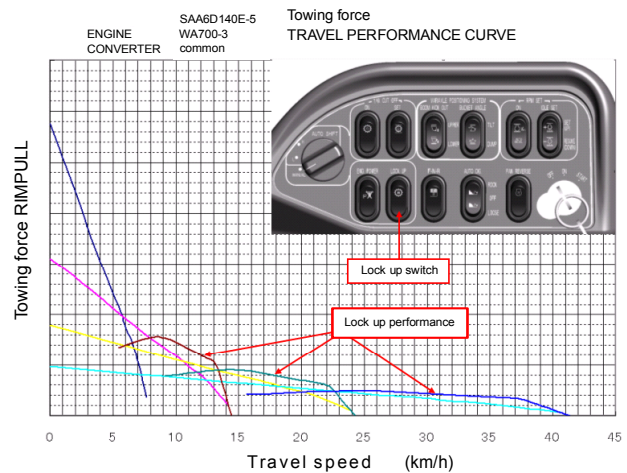

Fig. 5 Towing performance

Table 4 Comparison of fuel consumption of WA500-3 and WA500-6

In-house test values (Existing machine as being 100)

		WA500-3	WA500-6	
			Mode E	Mode P
V-shape loading (30s/cycle)	Fuel consumption liters/h	100	86	88
	Fuel economy m ³ /liter	100	128	125

3.3 Improvement of Controllability and Comfortability

Visibility has been improved and ease of work operation is assured to mitigate the operator load even though the dump truck to be loaded onto is wide-ranged.

(1) EPC (electric pilot control) work equipment lever

Taking into consideration the usage of the equipment of this class requiring dedicated operators to continuously operate for a long time, an EPC electric operation lever of a fingertip type featuring a short stroke and small operation force is adopted for work equipment to reduce the operator load. Furthermore, the following electronically controlled functions are added to lessen operation load.

1) Remote boom positioner

The maximum boom rise height and automatic boom downward stop height can be set operating in the operator's seat.

- Variable setting of the boom-raising stop position automatically stops at the optimum height of vessel of a dump truck even if the size of dump truck to be loaded onto is changed, eliminating the stop operation conventionally performed by the operator.

- Variable setting of the boom-lowering stop position

eliminates boom-lowering operation after unloading work.

These features greatly reduce work operation load during digging and loading (Fig. 6).

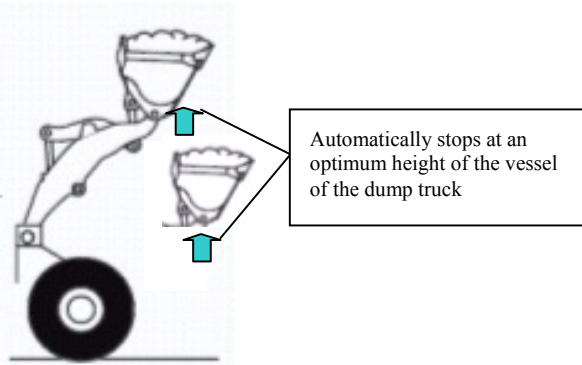

Fig. 6 Remote boom positioner

2) Remote bucket positioner

A function to set the bucket angle sitting on the operator's seat is adopted. In the past, the operator would adjust the edge angle when the bucket was located on the ground according to soil hardness at the site and operate by operating the work equipment lever. All this work is performed by automatic setting to reduce the operator load (Fig. 7).

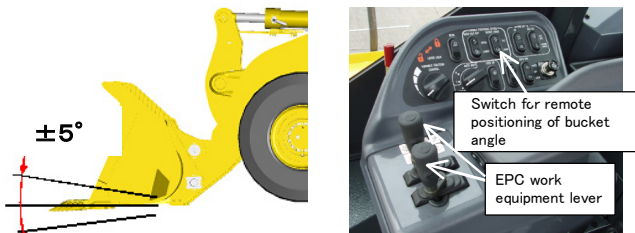

Fig. 7 EPC lever and remote bucket positioner

3) Semi-automatic digging function

A function for automatic bucket operation has been incorporated to lessen the operator load and to perform composite operation of the bucket and boom performed by skillful operators only by operating the boom lever. Two modes can be selected for digging, namely, product loading and crushing.

(2) ECSS (Electronically Controlled Suspension System)

Vehicle vibration caused by uneven surfaces of roads is damped to ensure excellent travel performance to mitigate operator fatigue. The damper minimizes spilling of bucket during loading and carrying work, thereby enhancing work efficiency (Fig. 8).

This function automatically activates when the travel speed increases, turning to "OFF" during digging. Thus, the function does not need switching while work is continued.

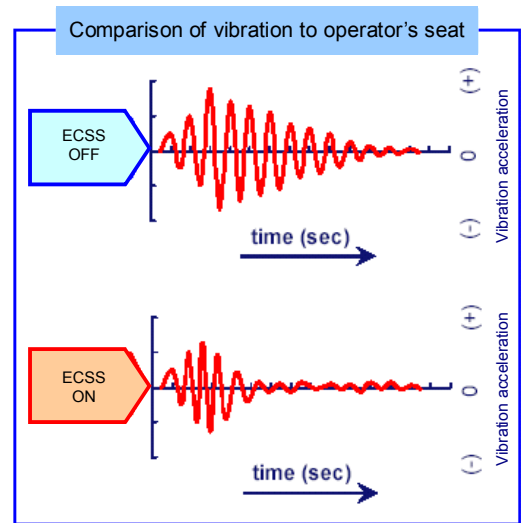

Fig. 8 Comparison of vibration to operator's seat

(3) Large armrests with adjusting mechanism

Large armrests that can be moved up and down and tilted are adopted. The operator can place the right arm on the armrest in a natural posture and maintain the upper half of the body naturally, operating the EPC work equipment lever with the fingers of the right hand (Fig. 9).

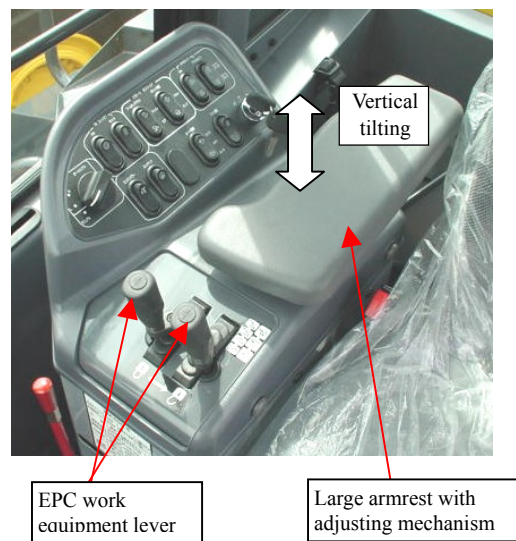

Fig. 9 Large armrests with adjusting mechanism

3.4 Improved Visibility

(1) Integral ROPS cab with large glass panes on all sides

The cab features a new design with large glass panes fitted on all sides, and the glass area is 12% larger compared with the conventional machine WA500-3. The new cab is an integral cab featuring ROPS and FOPS functions (Fig. 10).



Closed pressure type large pillarless cab featuring wide visibility

Fig. 10 Cab with large glass panes on all sides

(2) In conjunction with upgrading of vehicle classification to unload onto 32-ton dump trucks compared with 25-ton dump trucks with the conventional machine, the operator eye point has been raised by the high mount position of the cab. The operator can view the inside of the vessel of a dump truck being loaded onto, so that cargo will not be loaded unevenly (**Fig. 11**).

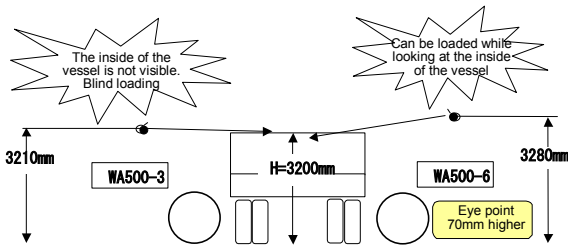

Fig. 11 Comparison of operator eye point height

(3) Improved rear visibility and improved visibility below radiator grill

While the vehicle classification is significantly upgraded, the rear non-visible distance has been shortened from 15.0 m with the conventional machine to 12.1 m (**Fig. 12**). A rear under-view mirror has been added to observe behind the radiator guard.

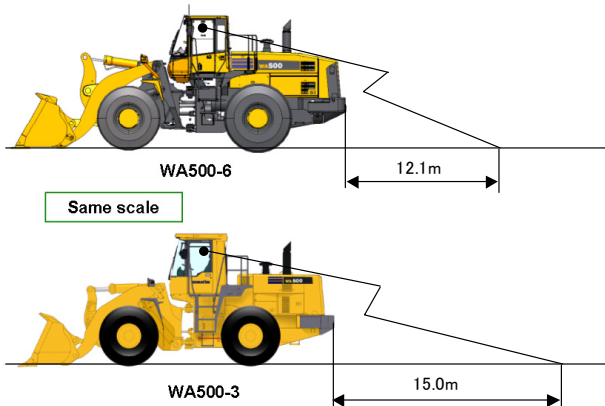

Fig. 12 Comparison of rear non-visible distance

3.5 Maintainability and Repairability

1) Swing out cooling fan

The hydraulic drive cooling fan can be swung out to improve the cleaning of the radiator cores while directly viewing them.

Clogging of the cores can be cleaned by blowing air by inversely driving the hydraulic drive fan (**Fig. 13**).

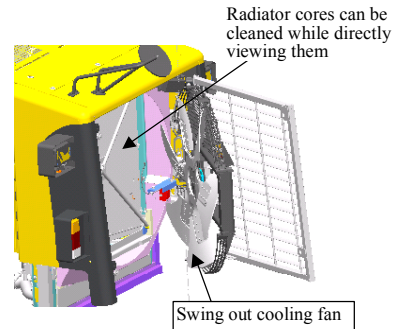

Fig. 13 Swing out cooling fan

2) Modular core radiator

The radiator is split into two modular cores. When a core is repaired, only the needed core is taken out and is mounted back without removing the radiator itself so that the time needed for repairs can be significantly shortened (**Fig. 14**).

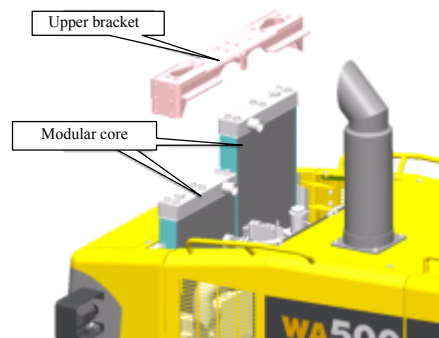

Fig. 14 Modular core radiator

3.6 Reliability and Durability

• Work equipment pin bushings

The bushings of work equipment pins have higher reliability and durability by carburizing and quenching bushings with thin grooves that excel in retaining lubricating performance and by providing a Defric coating. The pin bushings fully ensure work equipment performance with stricter specifications (**Fig. 15**).

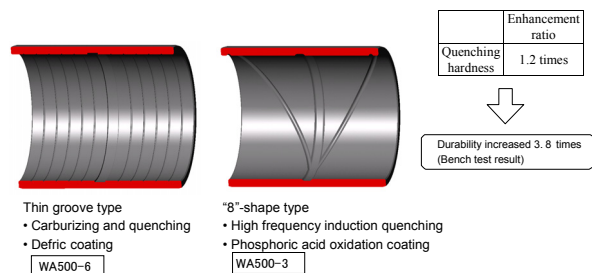

Fig. 15 Bushing with thin grooves

3.7 Versatility

An additional weight is adopted allowing retention of the departure angle of the standard vehicle even though an optional weight is installed for a variety of usages.

A standard weight, additional weight for high lifting and log-specification weight are available with the WA500-6.

The same departure angle as that with a standard weight is maintained so that a large margin is provided between the weight and the ground during scraping work (Fig. 16).

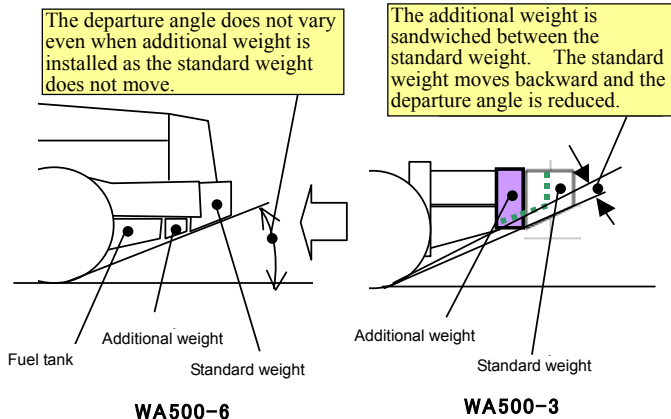

WA500-6

WA500-3

Fig. 16 Comparison of departure angle

3.8 Compliance with Exhaust Gas Regulation (Fig. 17)

The Tier-3 exhaust gas regulation is complied with while improving fuel consumption by installing the ecot3 engine, Komatsu's state-of-the-art technology. The principal changes are as follows.

- Installation of a cooled EGR (exhaust gas recirculation) system to lower the combustion temperature by feeding part of the exhaust gas again to the cylinder to curb the generation of NOx.
- Electronically controlled fuel injection optimizes combustion. Low air-intake temperature and low fuel consumption were accomplished by air cooled after cooling.
- A combination of a new large-diameter hybrid fan and its hydraulic driving increases the efficiency of the machine body cooling system and low noise to deal with increases in heat rejection by EGR and with EU Stage 2 noise regulation.

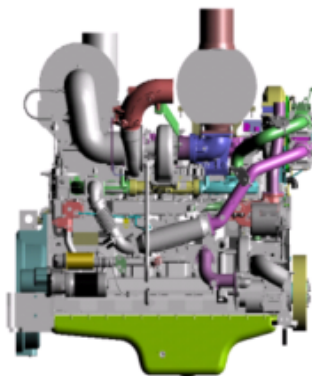

Fig. 17 Engine designed for exhaust gas regulation

3.9 Compliance with EU Stage 2 noise regulation

The regulatory noise level has been accomplished as planned by reducing noise emitted by sound sources through a slower rated speed of engine, through a change from a gear pump to a piston pump and through the adoption of a large-diameter, high-efficiency, low-noise hybrid fan. Additionally, exterior noise around the vehicle is reduced by installing a sound insulation wall in the engine room.

3.10 Reduction of hazardous substances

Faithful to Komatsu's low pollution concept, a lead-free radiator has been adopted. The radiator is an all-aluminum core radiator, eliminating soldering of copper tubes and fins that are soldered using lead solder.

3.11 IT Features

(1) EMMS (Equipment Management Monitoring System)

The monitor panel has a trouble diagnosis function and maintenance management function, displaying a failure code for a failure and machine maintenance status on a character display installed in the main monitor as necessary.

The design of the water thermometer, torque converter oil temperature gauge and other gauges has been changed entirely to further improve visibility.

In order to make indication for the promotion of the energy-saving operation, an eco lamp indicator is installed inside the monitor panel. It lights up and tells the operator if it is operated in energy saving according to the level of accelerator pedal (Photo 2).



Photo 2 Eco indicator

(2) KOMTRAX2

- 1) The operating position and status of the vehicle are traced.
- 2) Enhanced functions

Functions have been added in KOMTRAX2 compared with KOMTRAX1 (Table 5).

Table 5 Comparison of KOMTRAX functions

Function	KOMTRAX 2	KOMTRAX 1
Vehicle position	○	○
Service meter	○	○
Operational status	○	○
Operation map	○	○
Monthly operation status	○	○
No engine restart	○	○
Gauge level		
Fuel balance	◎	---
Engine water temperature	◎	---
Error history		
6-digit error code	◎	---
Caution		
Symbol mark	◎	---
Notify time to change		
Engine load factor	◎	---
Load frequency		
Engine load factor	◎	---

◎: Function upgraded in KOMTRAX2 ○: Function provided ---: Function not provided

4. Conclusion

The following major tasks were accomplished in this development project within the target schedule.

- 1) Compliance with EPA Tier-3 exhaust gas regulation, EU Tier-3 exhaust gas regulation and EU Stage 2 noise regulation.
- 2) Drastic improvement in fuel consumption as a “Dantotsu” feature.
- 3) A first full model change in nine years with upgraded vehicle classification.

In tackling these tasks, development efficiency was enhanced by advance research and parallel multi-item quality confirmation checks using bench tests and three prototype vehicles.

As a result, quality tasks could be completed almost as planned, enabling many development staff to learn various technologies.

These results will be useful in making subsequent development projects more efficient and smooth.

Introduction of the writer



Yasushi Hatanaka

Entered Komatsu in 1986.
Currently assigned to the Construction Equipment Technical Center 2, Development Division.



Kenji Misuda

Entered Komatsu in 1980.
Currently assigned to the Construction Equipment Technical Center 2, Development Division.



Kentarou Itou

Entered Komatsu.
Currently assigned to the Construction Equipment Technical Center 2, Development Division.

[A few words from the writer]

The last development project was one of the most impressive tasks among the development projects undertaken by the writers.

First, the project was characterized by: 1) The WA500 being a vehicle of vehicle classification that had the characteristics of both large and medium-size machines. 2) The vehicle being used in loading products. 3) The vehicle being run on general public roads. 4) The vehicle being produced in large numbers. 5) Two local corporations of Komatsu outside Japan manufacturing in large quantities.

Due to the limited time available, three prototypes were used to verify quality. The work to deal with corrective action items on the three prototype machines was a significantly large task exceeding the forecast. Various difficulties were encountered. Nevertheless, at present, volume production of the product at three plants in Japan, the USA and Europe has started more smoothly than anticipated. Field evaluation of the product is eagerly awaited.